

BOMBAS SUMERGIBLES

Presión de altura



bombaparaagua.com.mx



BOMBAS SUMERGIBLES

FUENTES Y ORNATO



CISTERNA



POZO PROFUNDO



ACHIQUE



- Motores de magnetos permanentes extra eficientes: muy bajo consumo energético, para uso continuo.
- Ideal para la recirculación de agua en fuentes y acuarios.
- Caídas y cortinas de agua.
- Incluye adaptador para manguera.



BOMBAS SUMERGIBLES

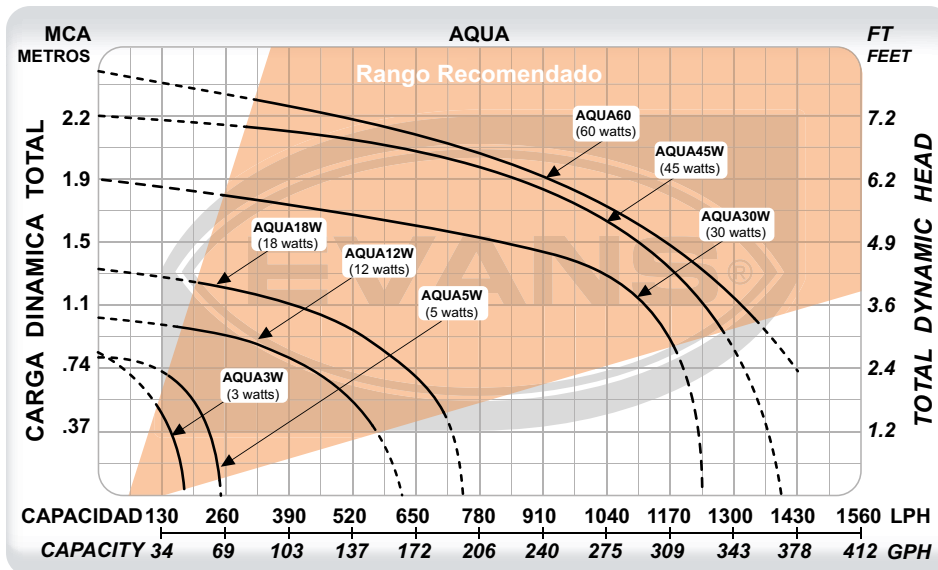

IMÁGEN DE REFERENCIA



CÓDIGO	PESO	MEDIDAS LARGO X ANCHO X ALTO
AQUA3W	0.25 kg	7 x 7 x 12 cm
AQUA5W	0.30 kg	11 x 9 x 8 cm
AQUA12W	0.44 kg	12 x 10 x 8 cm
AQUA18W	0.48 kg	12 x 10 x 9 cm
AQUA30W	0.86 kg	13 x 12 x 11 cm
AQUA45W	1.06 kg	16 x 11 x 12 cm
AQUA60W	1.76 kg	19 x 15 x 13 cm

CÓDIGO	Ø DESCARGA	POTENCIA	VOLTAJE	CORRIENTE	FLUJO MÁXIMO	PRESIÓN MÁXIMA	PUNTO DE MAYOR EFICIENCIA
AQUA3W	1/4"	3W	127 V ~ 60Hz 1Φ	54 mA	177 l/h	0.79 m	130 l/h a 0.5 m
AQUA5W	1/4"	5W	127 V ~ 60Hz 1Φ	62 mA	258 l/h	0.76 m	180 l/h a 0.7 m
AQUA12W	1/4"	12W	127 V ~ 60Hz 1Φ	180 mA	612 l/h	1.08 m	450 l/h a 0.75 m
AQUA18W	1/4"	18W	127 V ~ 60Hz 1Φ	240 mA	766 l/h	1.38 m	650 l/h a 0.75 m
AQUA30W	1/2"	30W	127 V ~ 60Hz 1Φ	490 mA	1236 l/h	1.99 m	1000 l/h a 1.3 m
AQUA45W	1/2"	45W	127 V ~ 60Hz 1Φ	900 mA	1422 l/h	2.20 m	1050 l/h a 1.5 m
AQUA60W	3/4"	60W	127 V ~ 60Hz 1Φ	1 A	1980 l/h	2.46 m	1100 l/h a 1.5 m



AQUA200W-F

- Motores de imanes permanentes extra eficientes: muy bajo consumo energético, para uso continuo.
- Ideal para la recirculación de agua en fuentes y acuarios.
- Óptimas para muros llorones.
- Incluye adaptador para manguera.



AQUA120W-F

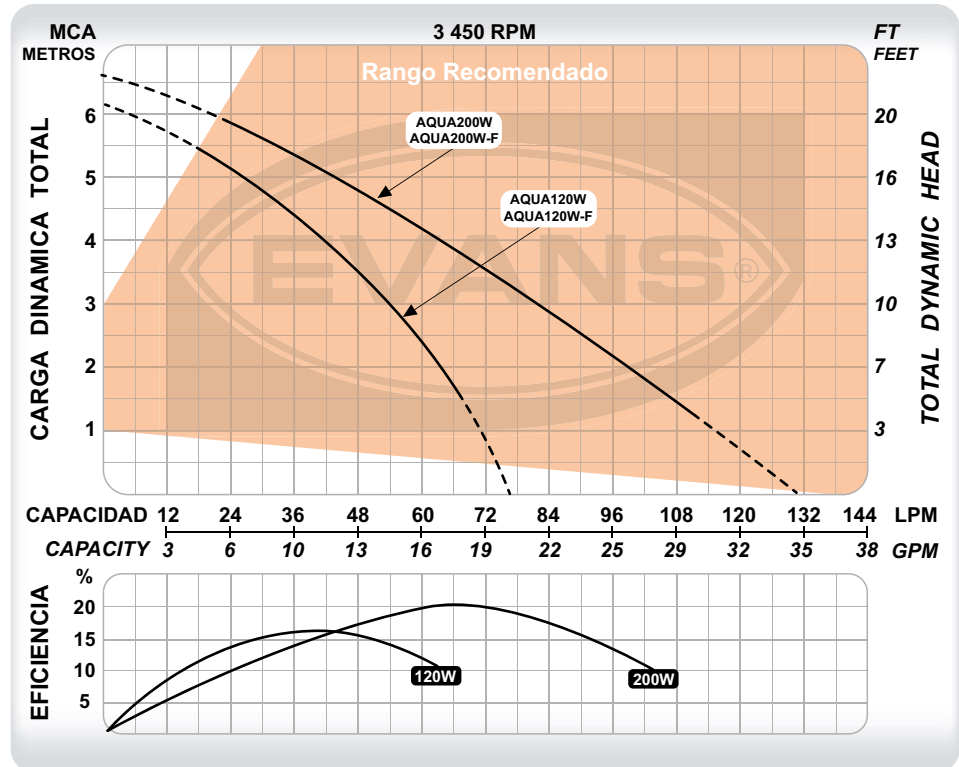

CÓDIGO	PESO	MEDIDAS LARGO X ANCHO X ALTO
AQUA120W	3.1 kg	17 x 17 x 28 cm
AQUA120W-F	3.3 kg	17 x 17 x 28 cm
AQUA200W	4.2 kg	16 x 16 x 30 cm
AQUA200W-F	4.5 kg	16 x 16 x 30 cm

CÓDIGO	Ø DESCARGA	POTENCIA	VOLTAJE	CORRIENTE	FLUJO MÁXIMO	PRESIÓN MÁXIMA	PUNTO DE MAYOR EFICIENCIA
AQUA120W	1"	120W	115 V ~ 60Hz 1Φ	2.1 A	73 l/min	6m	40 l/ min a 4 m
AQUA120W-F	1"	120W	115 V ~ 60Hz 1Φ	2.1 A	73 l/min	6 m	40 l/ min a 4 m
AQUA200W	1 ¼"	200W	115 V ~ 60Hz 1Φ	2.38 A	129 l/min	6.5 m	65 l/ min a 4 m
AQUA200W-F	1 ¼"	200W	115 V ~ 60Hz 1Φ	2.38 A	129 l/min	6.5 m	65 l/ min a 4 m



- Creación de juegos de agua y fuentes de ornato.
- Incluye todos los accesorios necesarios para crear diferentes estilos de fuente.
- Motores de magnetos permanentes extra eficientes: muy bajo consumo energético, para uso continuo.



BOMBAS SUMERGIBLES

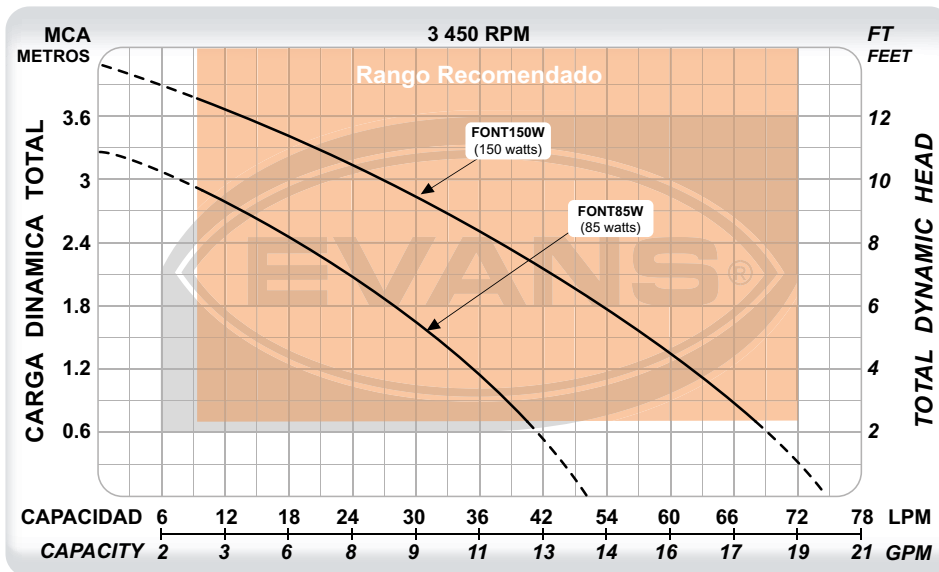

CÓDIGO	PESO	MEDIDAS LARGO X ANCHO X ALTO
FONT85W	2.3 kg	22 x 20 x 15 cm
FONT150W	3.57 kg	24 x 21 x 15 cm

CÓDIGO	Ø DESCARGA	POTENCIA	VOLTAJE	CORRIENTE	FLUJO MÁXIMO	PRESIÓN MÁXIMA	PUNTO DE MAYOR EFICIENCIA
FONT85W	3/4"	85 W	127 V ~ 60Hz 1Φ	1.15 A	49 l/min	3.19 m	27 l/min a 1.8 m
FONT150W	3/4"	150 W	127 V ~ 60Hz 1Φ	1.85 A	74 l/min	3.93 m	27 l/min a 3 m



CLASE 1G

CISTERNA DOMÉSTICA

Abastecimiento de agua confiable

BOMBAS SUMERGIBLES



- La de mayor presión en su categoría. 50% más altura que la competencia.
- Ideal para el rápido llenado de tinacos de manera totalmente silenciosa.
- Uso exclusivo con agua limpia.
- Anticorrosiva por sus materiales en plástico.



DIAGRAMA DE INSTALACIÓN



CÓDIGO	PESO	MEDIDAS LARGO X ANCHO X ALTO
SLA1.5ME050	6 kg	22 x 16 x 36 cm
SLA1.5ME050G	6 kg	22 x 16 x 36 cm

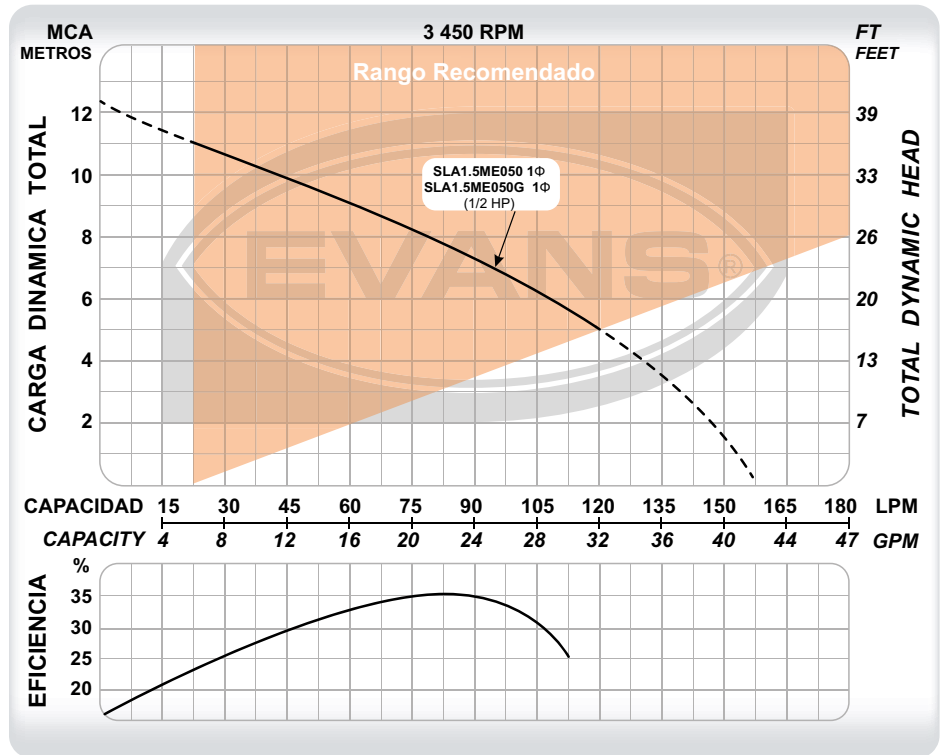

CÓDIGO	Ø DESCARGA	POTENCIA	VOLTAJE	CORRIENTE	FLUJO MÁXIMO	PRESIÓN MÁXIMA	PUNTO DE MAYOR EFICIENCIA
SLA1.5ME050	1 ½"	1/2 HP	115 V ~ 60Hz 1Φ	4.2 A	158 l/min	12 m	90 l/min a 7.5m
SLA1.5ME050G	1 ½"	1/2 HP	220 V ~ 60Hz 1Φ	2.1 A	158 l/min	12 m	90 l/min a 7.5m



- Equipo altamente eficiente: excelente altura y flujo con bajo consumo energético.
- Ideales para el rápido llenado de tinacos de manera totalmente silenciosa.
- Uso exclusivo con agua limpia.



SP1ME050H

BOMBAS SUMERGIBLES

SELECCIONA TU MOTOBOMBA SUMERGIBLE

CONSUMO ESTIMADO DE 300 LITROS DE GASTO AL DÍA POR PERSONA.		NÚMERO PERSONAS	2i	4i	6i	10i	PARA SELECCIONAR EL DIÁMETRO DE LA TUBERÍA CONSULTE LAS TABLAS DE PÉRDIDA POR FRICCIÓN.
CAPACIDAD EN LITROS EN TINACO			600	1100	2200	3300	
CASA HABITACIÓN	#de Pisos		1/2hp	1/2hp	3/4hp	3/4hp	Ø DE TUBERÍA
	6 metros	1	6min.	10min.	18min.	28min.	1/2" Tubería NO recomendada
	9 metros	2	7min.	12min.	20min.	22min.	3/4" Tubería NO recomendada
	12 metros	3	7min.	13min.	17min.	25min.	1" 0-15
			3/4hp	3/4hp	1hp	1hp	1 1/4" 0-35
			7min.	13min.	17min.	25min.	1" 0-60
			7min.	13min.	17min.	25min.	1 1/4" 0-95

DIAGRAMA DE INSTALACIÓN

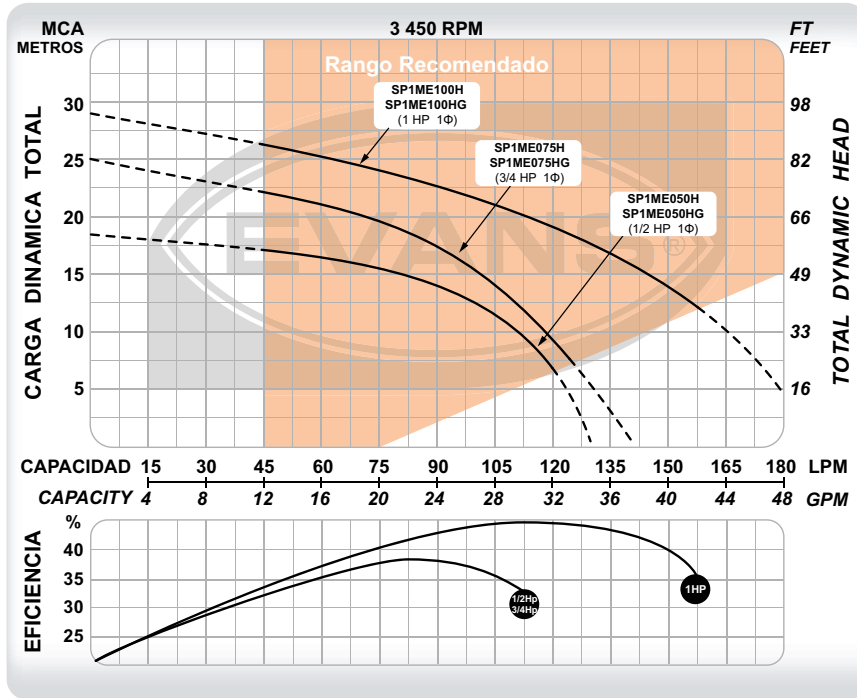

CÓDIGO	PESO	MEDIDAS LARGO X ANCHO X ALTO
SP1ME050H	11 kg	40 x 19 x 10 cm
SP1ME075H	14 kg	41 x 23 X 22 cm
SP1ME100H	17 kg	41 x 23 X 22 cm
SP1ME050HG	11 kg	40 x 19 x 10 cm
SP1ME075HG	14 kg	41 x 23 X 22 cm
SP1ME100HG	17 kg	41 x 23 X 22 cm

CÓDIGO	Ø DESCARGA	POTENCIA	VOLTAJE	CORRIENTE	FLUJO MÁXIMO	PRESIÓN MÁXIMA	PUNTO DE MAYOR EFICIENCIA
SP1ME050H	1"	1/2 HP	127 V ~ 60Hz 1Φ	6.5 A	130 l/min	19 m	85 l/min a 15 m
SP1ME075H	1"	3/4 HP	127 V ~ 60Hz 1Φ	8.5 A	140 l/min	25 m	85 l/min a 18 m
SP1ME100H	1"	1 HP	127 V ~ 60Hz 1Φ	10.5 A	190 l/min	29.5 m	120 l/min a 18 m
SP1ME050HG	1"	1/2 HP	220 V ~ 60Hz 1Φ	3.3 A	130 l/min	19 m	85 l/min a 15 m
SP1ME075HG	1"	3/4 HP	220 V ~ 60Hz 1Φ	4.3 A	140 l/min	25 m	85 l/min a 18 m
SP1ME100HG	1"	1 HP	220 V ~ 60Hz 1Φ	5.3 A	190 l/min	29.5 m	120 l/min a 18 m



CLASE 1G

CISTERNA RESIDENCIAL

Disfruta la presión del agua

BOMBAS SUMERGIBLES



SPM1ME100F-F

SUM4ME100F-F

- Opción versátil para la presurización en casas de hasta 3 niveles.
- Ideales para sistemas de presión con hidroneumático y/o Control-Press o Easy-press®.
- Extra resistente por sus materiales en hierro gris y acero inoxidable.



DIAGRAMA DE INSTALACIÓN



CÓDIGO	PESO	MEDIDAS LARGO X ANCHO X ALTO
SPM1ME075F-F	9 kg	45 x 18 x 22 cm
SPM1ME100F-F	10 kg	50 x 18 x 22 cm
SUM3ME075F-F	8.9 kg	18 x 21 x 53 cm
SUM4ME100F-F	9.6 kg	18 x 21 x 55 cm

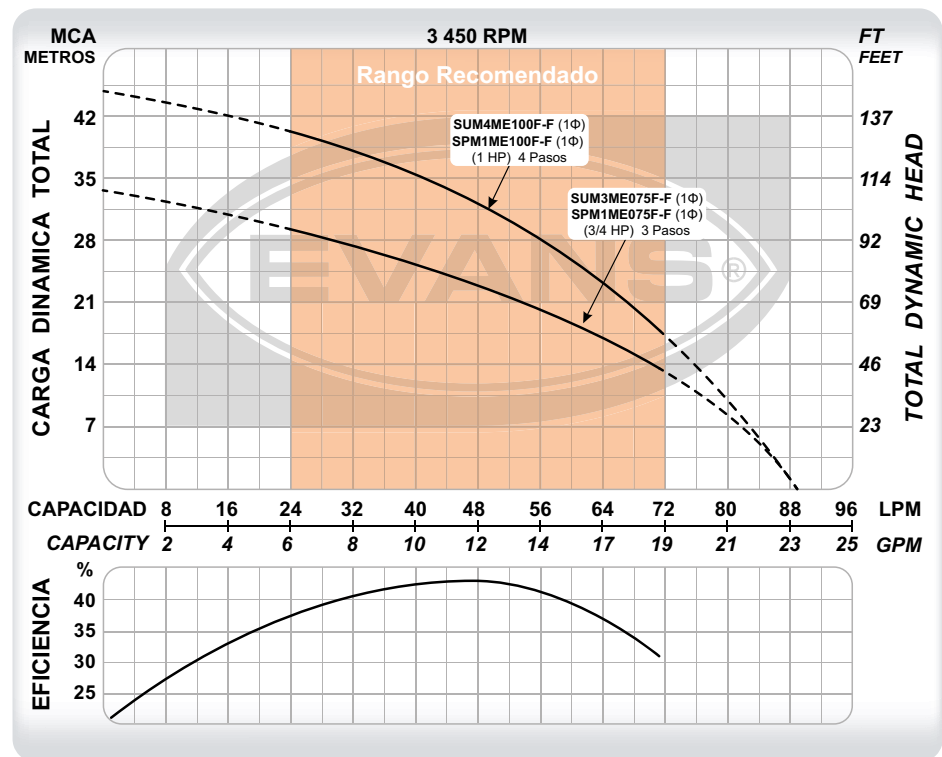

CÓDIGO	Ø DESCARGA	POTENCIA	VOLTAJE	CORRIENTE	ETAPAS	FLUJO MÁXIMO	PRESIÓN MÁXIMA	PUNTO DE MAYOR EFICIENCIA
SPM1ME075F-F	1"	3/4 HP	115 V ~ 60Hz 1Φ	6.9 A	3	90 l/min	33 m	48 l/min a 23 m
SPM1ME100F-F	1"	1 HP	115 V ~ 60Hz 1Φ	9 A	4	90 l/min	45 m	48 l/min a 32 m
SUM3ME075F-F	1"	3/4 HP	127 V ~ 60Hz 1Φ	6 A	3	90 l/min	33 m	48 l/min a 23 m
SUM4ME100F-F	1"	1 HP	127 V ~ 60Hz 1Φ	7.5 A	4	90 l/min	45 m	48 l/min a 32 m

CISTERNA RESIDENCIAL O POZOS PROFUNDOS

Disfruta la presión del agua

CLASE II



- Modelos con flotador: ideales para presurizar residencias o pequeños comercios con hidroneumático y/o Control-Press®.
- Modelos sin flotador: ideales para extracción de agua en pozos desde 4" de ademe. Motor de 2 hilos muy sencillo de instalar: no necesita caja de control.
- Impulsores tipo flotantes fabricados en Poliacetal (POM).
- Succión inferior para el máximo aprovechamiento del volumen total de agua dentro de la cisterna.



BOMBAS SUMERGIBLES

DIAGRAMA DE INSTALACIÓN

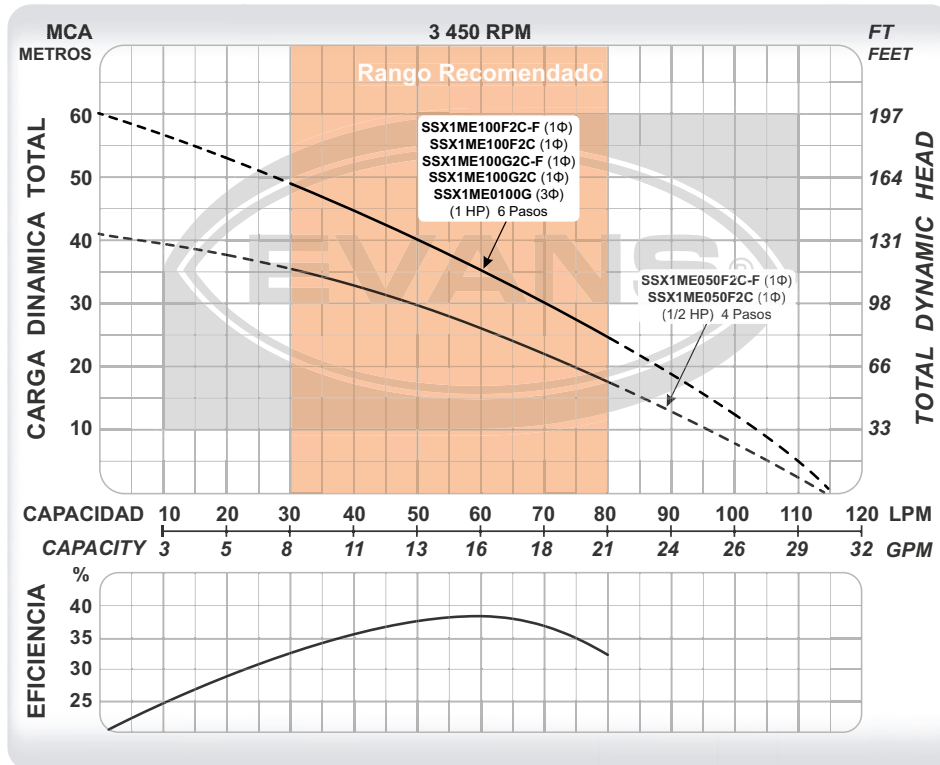

CÓDIGO	PESO	MEDIDAS LARGO X ANCHO X ALTO
SSX1ME050F2C	13 kg	71 x 15 x 15 cm
SSX1ME050F2C-F	13 kg	71 x 15 x 15 cm
SSX1ME100F2C	14.5 kg	82 x 15 x 16 cm
SSX1ME100F2C-F	14.5 kg	82 x 15 x 20 cm
SSX1ME100G2C	14.5 kg	82 x 15 x 16 cm
SSX1ME100G2C-F	14.5 kg	82 x 15 x 20 cm
SSX1ME0100G	14.5 kg	82 x 15 x 16 cm

CÓDIGO	Ø DESCARGA	POTENCIA	VOLTAJE	CORRIENTE	ETAPAS	FLUJO MÁXIMO	PRESIÓN MÁXIMA	PUNTO DE MAYOR EFICIENCIA
SSX1ME050F2C	1 ¼"	1/2 HP	115 V ~ 60Hz 1Φ	8.8 A	4	115 l/min	41.6 m	60 l/min a 26 m
SSX1ME050F2C-F	1 ¼"	1/2 HP	115 V ~ 60Hz 1Φ	8.8 A	4	115 l/min	41.6 m	60 l/min a 26 m
SSX1ME100F2C	1 ¼"	1 HP	115 V ~ 60Hz 1Φ	12.5 A	6	115 l/min	61 m	60 l/min a 35 m
SSX1ME100F2C-F	1 ¼"	1 HP	115 V ~ 60Hz 1Φ	12.5 A	6	115 l/min	61 m	60 l/min a 35 m
SSX1ME100G2C	1 ¼"	1 HP	220 V ~ 60Hz 1Φ	6.3 A	6	115 l/min	61 m	60 l/min a 35 m
SSX1ME100G2C-F	1 ¼"	1 HP	220 V ~ 60Hz 1Φ	6.3 A	6	115 l/min	61 m	60 l/min a 35 m
SSX1ME0100G	1 ¼"	1 HP	220 V ~ 60Hz 3Φ	4.2 A	6	115 l/min	61 m	60 l/min a 35 m

BOMBAS SUMERGIBLES



-
-
-
-
-
-
-
-

- Bomba automática con electrónica integrada.
- Equivalente a instalar una SSX1 con Control-Press®.
- Puede instalarse con un pequeño tanque hidroneumático.
- Impulsores tipo flotantes fabricados en Poliacetal (POM).
- Succión inferior para el máximo aprovechamiento del volumen total de agua dentro de la cisterna.

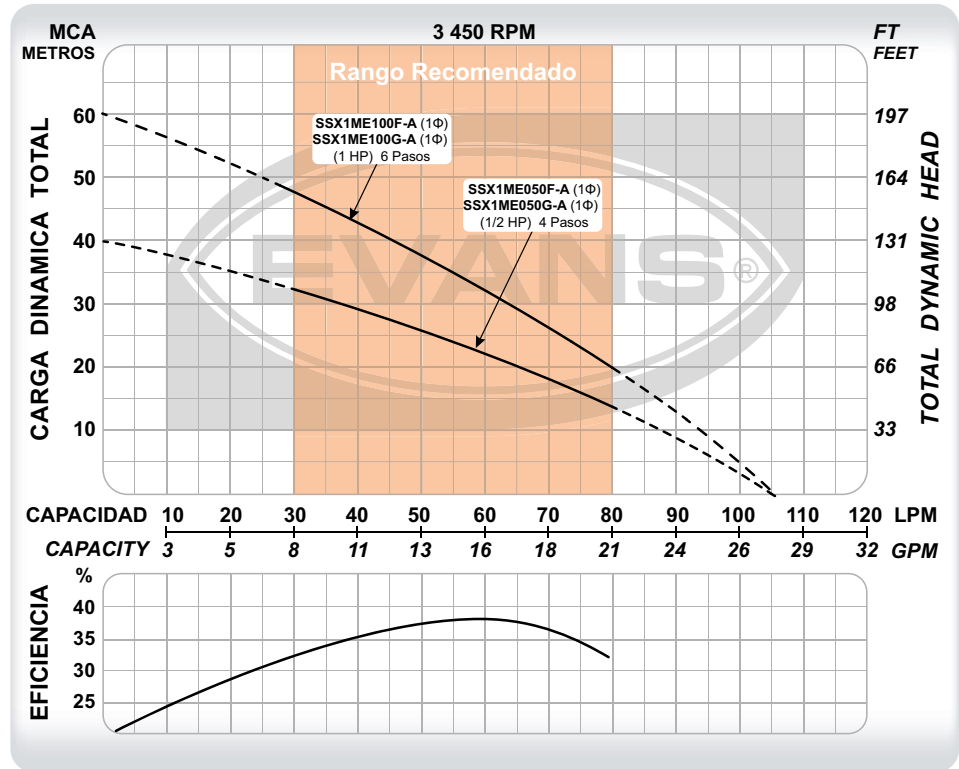

CÓDIGO	PESO	MEDIDAS
		LARGO X ANCHO X ALTO
SSX1ME050F-A	8.5 kg	80 x 15 x 23 cm
SSX1ME100F-A	10 kg	97 x 15 x 23 cm
SSX1ME050G-A	8.5 kg	80 x 15 x 23 cm
SSX1ME100G-A	10 kg	97 x 15 x 23 cm

CÓDIGO	Ø DESCARGA	POTENCIA	VOLTAJE	CORRIENTE	ETAPAS	FLUJO MÁXIMO	PRESIÓN MÁXIMA	PUNTO DE MAYOR EFICIENCIA
SSX1ME050F-A	1"	1/2 HP	115 V ~ 60Hz 1Φ	8.8 A	4	105 l/min	40 m	60 l/min a 25 m
SSX1ME100F-A	1"	1 HP	115 V ~ 60Hz 1Φ	12.5 A	6	105 l/min	60 m	60 l/min a 34 m
SSX1ME050G-A	1"	1/2 HP	220 V ~ 60Hz 1Φ	4.4 A	4	105 l/min	40 m	60 l/min a 25 m
SSX1ME100G-A	1"	1 HP	220 V ~ 60Hz 1Φ	6.3 A	6	105 l/min	60 m	60 l/min a 34 m

POZO PROFUNDO 4" | 18 GPM

Desempeño de altura

CLASE II



- Ideal para extraer agua de pozos de 4" de ademe y hasta 100 m de profundidad.
- Motor de 2 hilos muy sencillo de instalar: no necesita caja de control.
- Impulsores tipo flotantes fabricados en Poliacetal (POM).
- Confiabilidad para obtener un bombeo de agua más limpia sin absorber partículas grandes del pozo.



BOMBAS SUMERGIBLES

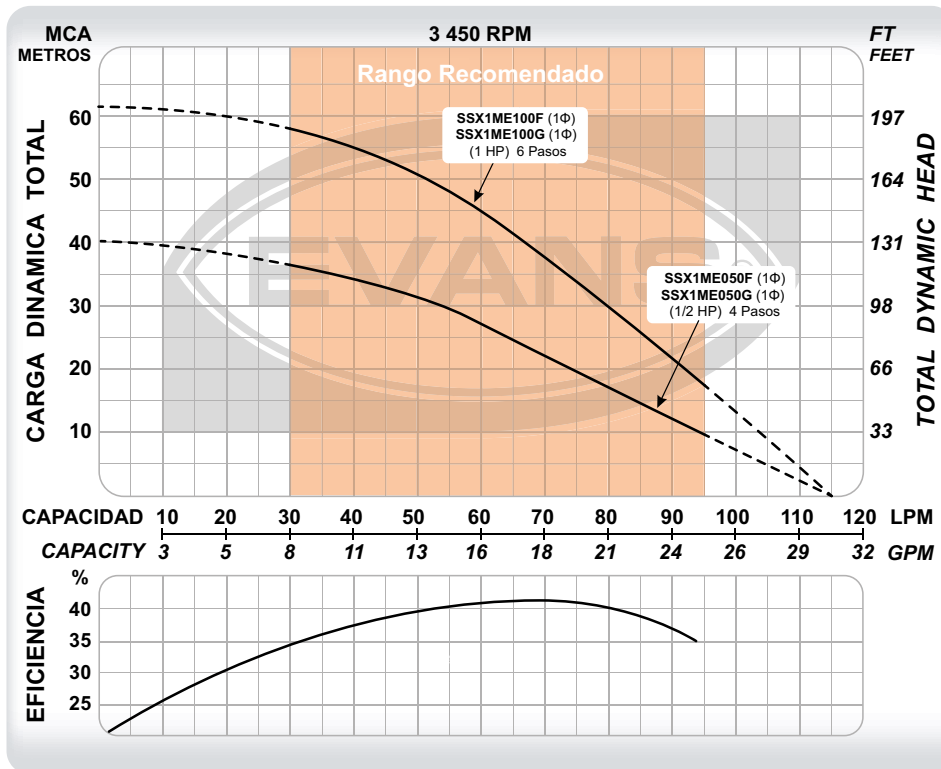

CÓDIGO	PESO	MEDIDAS LARGO X ANCHO X ALTO
SSX1ME050F	8 kg	80 x 15.5 x 15 cm
SSX1ME050G	8 kg	80 x 15.5 x 15 cm
SSX1ME100F	9 kg	91 x 15.5 x 15 cm
SSX1ME100G	9 kg	91 x 15.5 x 15 cm

CÓDIGO	Ø DESCARGA	POTENCIA	VOLTAJE	CORRIENTE	ETAPAS	FLUJO MÁXIMO	PRESIÓN MÁXIMA	PUNTO DE MAYOR EFICIENCIA
SSX1ME050F	1 ¼"	1/2 HP	115 V ~ 60Hz 1Φ	8 A	4	115 l/min	40 m	70 l/min a 23 m
SSX1ME050G	1 ¼"	1/2 HP	220 V ~ 60Hz 1Φ	4 A	4	115 l/min	40 m	70 l/min a 23 m
SSX1ME100F	1 ¼"	1 HP	115 V ~ 60Hz 1Φ	13 A	6	115 l/min	61 m	70 l/min a 38 m
SSX1ME100G	1 ¼"	1 HP	220 V ~ 60Hz 1Φ	7 A	6	115 l/min	61 m	70 l/min a 38 m



CLASE II

POZO PROFUNDO 4" | 18 GPM

Desempeño de altura

BOMBAS SUMERGIBLES



- Ideal para extraer agua de pozos de 4" de ademe y hasta 100 m de profundidad.
- Motor de 2 hilos muy sencillo de instalar: no necesita caja de control.
- Impulsores tipo flotantes fabricados en Poliacetal (POM).
- Confiabilidad para obtener un bombeo de agua más limpia sin absorber partículas grandes del pozo.

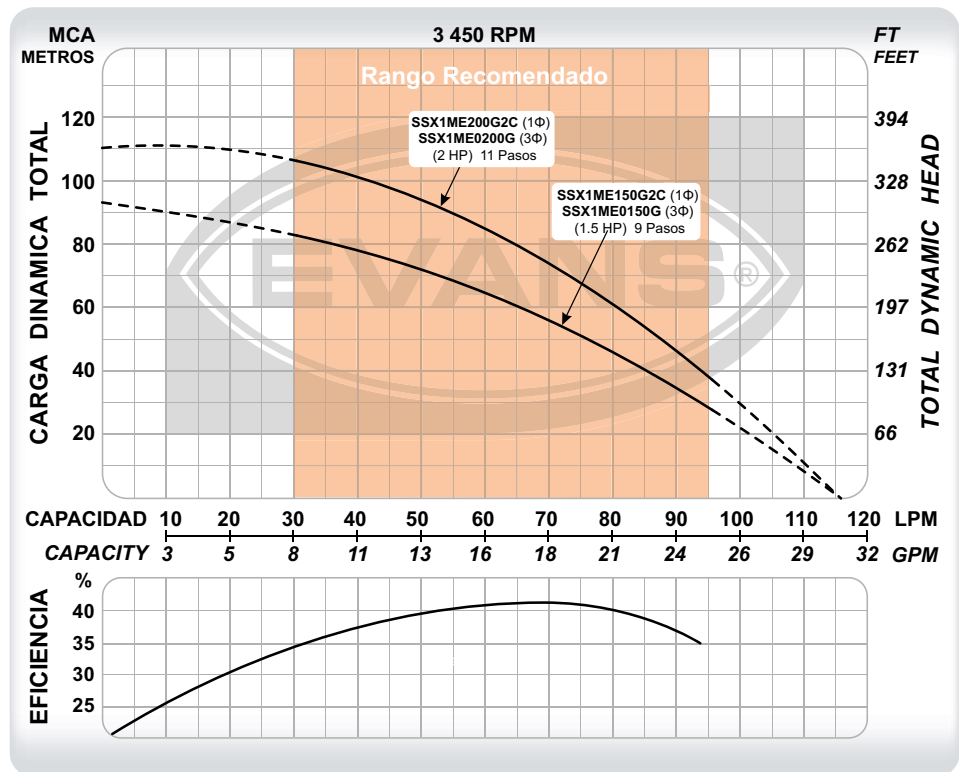

CÓDIGO	PESO	MEDIDAS
		LARGO X ANCHO X ALTO
SSX1ME150G2C	11 kg	103 x 15 X 14 cm
SSX1ME200G2C	12 kg	114 x 15 x 14 cm
SSX1ME0150G	11 kg	97 x 15 x 14 cm
SSX1ME0200G	12 kg	107 x 15 x 14 cm

CÓDIGO	Ø DESCARGA	POTENCIA	VOLTAJE	CORRIENTE	ETAPAS	FLUJO MÁXIMO	PRESIÓN MÁXIMA	PUNTO DE MAYOR EFICIENCIA
SSX1ME150G2C	1 ¼"	1.5 HP	220 V ~ 60Hz 1Φ	9 A	9	115 l/min	91 m	70 l/min a 55 m
SSX1ME200G2C	1 ¼"	2 HP	220 V ~ 60Hz 1Φ	12 A	11	115 l/min	110 m	70 l/min a 72 m
SSX1ME0150G	1 ¼"	1.5 HP	220 V ~ 60Hz 3Φ	6 A	9	115 l/min	91 m	70 l/min a 55 m
SSX1ME0200G	1 ¼"	2 HP	220 V ~ 60Hz 3Φ	8 A	11	115 l/min	110 m	70 l/min a 72 m

CISTERNA USO COMERCIAL

Disfruta la presión del agua

CLASE II



- Equipo ideal para la presurización de comercios ó pequeñas industrias.
- Excelente opción para instalarse en equipos multibomba con variadores de frecuencia.
- Succión inferior para el máximo aprovechamiento del volumen total de agua dentro de la cisterna.
- Impulsores fabricados en acero inoxidable 304.



BOMBAS SUMERGIBLES

LAS BOMBAS MONOFÁSICAS: 220 V INCLUYEN FLOTADOR | 115 V INCLUYEN CAJA DE CONTROL

DIAGRAMA DE INSTALACIÓN PARA HIDRONEUMÁTICO

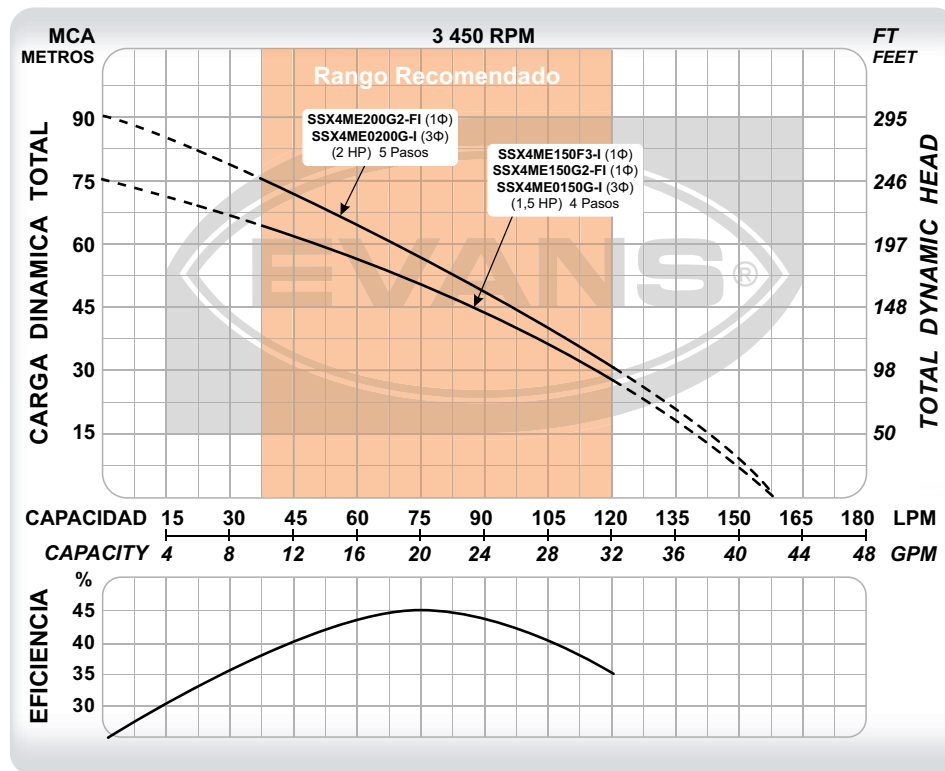

CÓDIGO	PESO	MEDIDAS LARGO X ANCHO X ALTO
SSX4ME150F3-I	16 kg	79 x 21 x 15 cm
SSX4ME150G2-FI	16.5 kg	60 x 20 x 20 cm
SSX4ME200G2-FI	18.5 kg	62 x 20 x 20 cm
SSX4ME0150G-I	16 kg	60 x 20 x 20 cm
SSX4ME0200G-I	18 kg	62 x 20 x 20 cm

CÓDIGO	Ø DESCARGA	POTENCIA	VOLTAJE	CORRIENTE	ETAPAS	FLUJO MÁXIMO	PRESIÓN MÁXIMA	PUNTO DE MAYOR EFICIENCIA
SSX4ME150F3-I	1 ¼"	1.5 HP	115 V ~ 60Hz 1Φ	15 A	4	155 l/min	75 m	75 l/min a 50 m
SSX4ME150G2-FI	1 ¼"	1.5 HP	220 V ~ 60Hz 1Φ	8.4 A	4	155 l/min	75 m	75 l/min a 50 m
SSX4ME200G2-FI	1 ¼"	2 HP	220 V ~ 60Hz 1Φ	10.6 A	5	155 l/min	91 m	75 l/min a 55 m
SSX4ME0150G-I	1 ¼"	1.5 HP	220 V ~ 60Hz 3Φ	6.2 A	4	155 l/min	75 m	75 l/min a 50 m
SSX4ME0200G-I	1 ¼"	2 HP	220 V ~ 60Hz 3Φ	8.2 A	5	155 l/min	91 m	75 l/min a 55 m

El acoplamiento de los motores sumergibles EVANS® de 4" cumple los estándares de la Asociación Nacional de Manufactura Eléctrica (NEMA) y siendo compatible con las unidades de bombeo de diferentes marcas que tengan cumplimiento NEMA. Consulta a tu Asesor EVANS®.

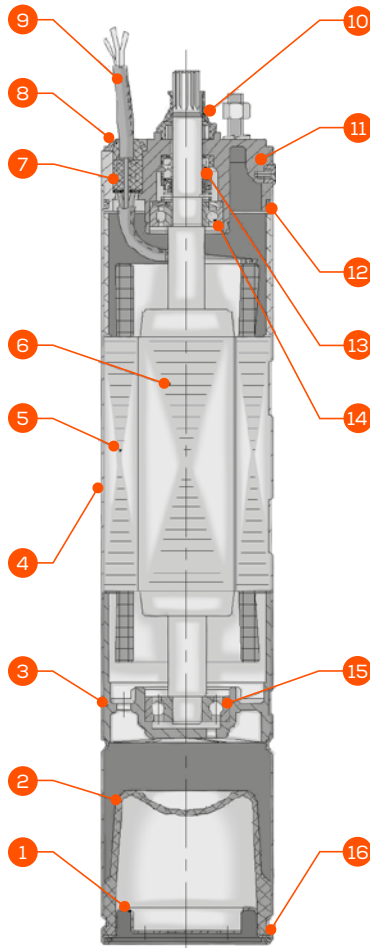
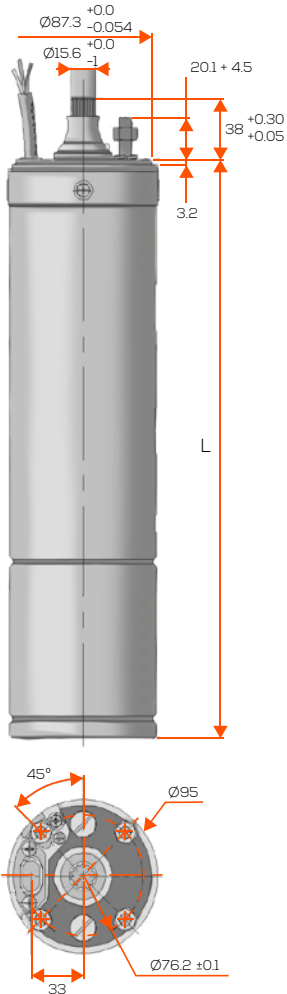

No.	COMPONENTES
1	Protección inferior
2	Diafragma de compensación
3	Soporte inferior
4	Cubierta motor
5	Estator
6	Rotor
7	Glándula cable
8	Abrazadera cable
9	Cable
10	Cubierta anti arena
11	Soporte superior
12	O-ring
13	Sello mecánico
14	Balero superior
15	Balero inferior
16	Anillo base

MATERIALES DE MOTOR	
Material del cuerpo	AISI 304
Rotor / Flecha	AISI 316. Una sola pieza
Sello mecánico	Grafito/ cerámica/ NBR/ AISI 304
Submersibilidad	120 m
Rodamientos	Cerámica / Buna-N
Aceite	Mineral blanco. SINOPEC #25
Acoplamiento	NEMA
Temperatura máx.	35 °C
Rango de pH del agua	5.5 - 8.9

Las unidades están dadas en mm.

CÓDIGO	POTENCIA (HP)	L (cm)	PESO (kg)	VOLTAJE	CORRIENTE NOMINAL (A)	FACTOR SERVICIO	CORRIENTE MAX. (A)	EMPUJE AXIAL (N)				
E24S050F3-P	1/2	35.8	8	110V ~ 60Hz 1Φ	6.8	1.6	10.9	1 500				
E24S050G3-P			7.8	220V ~ 60Hz 1Φ	3.7		6					
E24S0050G-P			7	220V ~ 60Hz 3Φ	2.1		3.4					
E24S100F3-P	1	40.3	10.2	110V ~ 60Hz 1Φ	11	1.4	15.5		2 500			
E24S100G3-P			10	220V ~ 60Hz 1Φ	5.5		7.6					
E24S0100G-P			9.4	220V ~ 60Hz 3Φ	3.9		5.5					
E24S150F3-P	1.5	43.3	11	110V ~ 60Hz 1Φ	14.4	1.3	18.9	4 500				
E24S150G3-P			10.8	220V ~ 60Hz 1Φ	7.2		9.4					
E24S0150G-P			10	220V ~ 60Hz 3Φ	5		6.4					
E24S200G3-P	2	47.8	12.6	220V ~ 60Hz 1Φ	9.6	1.25	12		2 500			
E24S0200G-P			11.7	220V ~ 60Hz 3Φ	6.5		8.2					
E24S300G3-P	3	52.3	14.8	220V ~ 60Hz 1Φ	13.6	1.15	15.6			4 500		
E24S0300G-P			14.3	220V ~ 60Hz 3Φ	9.5		10.9					
E24S500G3-P	5	56.4	21.8	220V ~ 60Hz 1Φ	22.5		1.15	25.9			4 500	
E24S0500G-P			21.3	220V ~ 60Hz 3Φ	15			17.3				
E24S0750G-P	7.5	78.3	27	220V ~ 60Hz 3Φ	22.6			1.15	25.9			4 500
E24S1000G-P	10	90.3	33.3	220V ~ 60Hz 3Φ	31.5				36.2			
E24S1250G-P	12.5	92.3	35	220V ~ 60Hz 3Φ	39	44.9						

COMPONENTES	
No.	PARTES
1	Descarga
2	Válvula check
3	O-ring
4	Soporte de válvula check
5	Buje del rodamiento
6	Rodamiento superior
7	Soporte de flecha superior
8	Arandela anti fricción
9	Impulsor
10	Cubierta del difusor
11	Difusor
12	Cuerpo de bomba
13	Acoplamiento
14	Filtro
15	Soporte de succión
16	Tornillo M5 x 8
17	Buje del rodamiento
18	Rodamiento inferior
19	Soporte de flecha inferior
20	Junta
21	Cubierta de cable
22	Distanciador
23	Flecha
24	Arandela M6
25	Arandela M6
26	Perno sujetador M6 x 16
27	Abrazadera de cubierta del cable
28	Tornillo M5 x 8
29	Cubierta
30	Anillo elástico de fijación

COMPONENTES	
Material del cuerpo	AISI 304
Descarga	AISI 304
Succión	AISI 304
Flecha de bomba	AISI 420
Cople	AISI 420
Protector de cable	AISI 304
Bushing superior e inferior	AISI 420
Soporte de válvula check	PC y fibra de vidrio
Impulsores	Noryl®
Difusores	PC y fibra de vidrio
Válvula check	POM
Rodamientos de bomba	Cerámica / Buna-N
Acoplamiento	NEMA
Máx. contenido de arena	15% ~ 150 g/m³
Rango de pH del agua	5.5 - 8.9

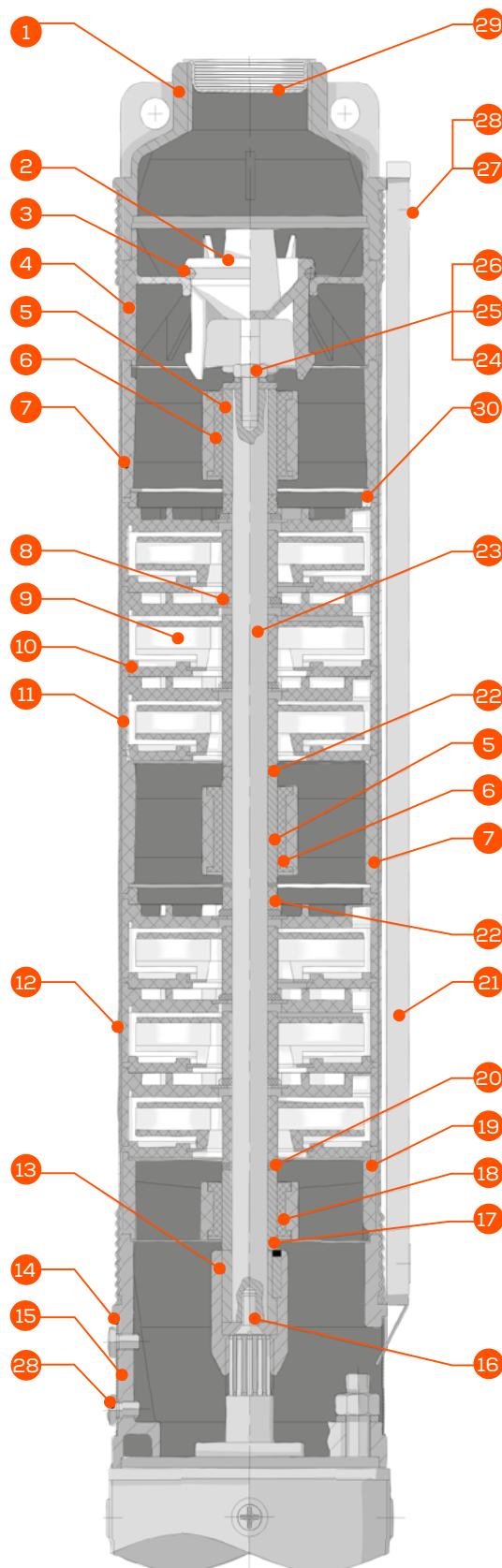



1
año
GARANTÍA

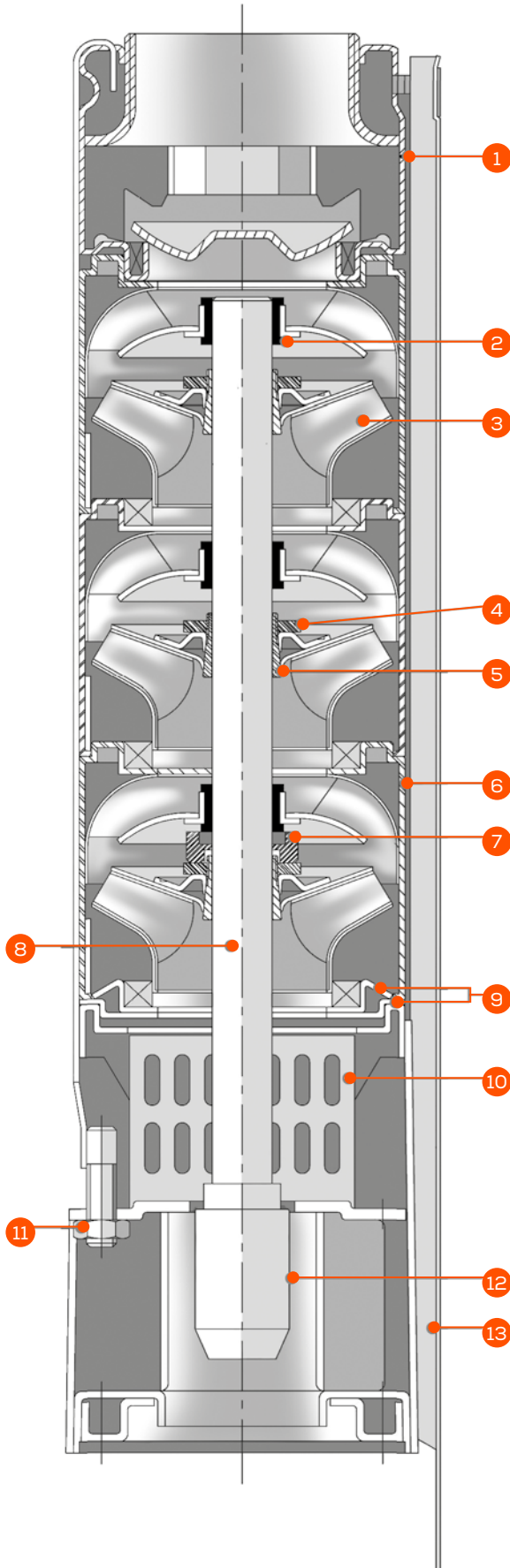

COMPONENTES	
No.	PARTES
1	Descarga
2	Rodamiento
3	Impulsor
4	Tuerca del separador
5	Separador de etapas
6	Difusor
7	Anillo de sujeción
8	Flecha
9	Retén
10	Rejilla de succión
11	Tornillo y tuerca
12	Cople
13	Guardacable

MATERIALES DE UNIDAD DE BOMBEO	
Material del cuerpo	AISI 304
Descarga	AISI 304
Succión	AISI 304
Flecha de bomba	AISI 431
Cople	AISI 304
Protector de cable	AISI 304
Soporte de válvula check	AISI 304
Impulsores	AISI 304
Difusores	AISI 304
Válvula check	AISI 304
Rodamientos de bomba	Buna-N
Acoplamiento	NEMA
Máx. contenido de arena	5% ~ 50g/m ³
Rango de pH del agua	5.5 - 8.9

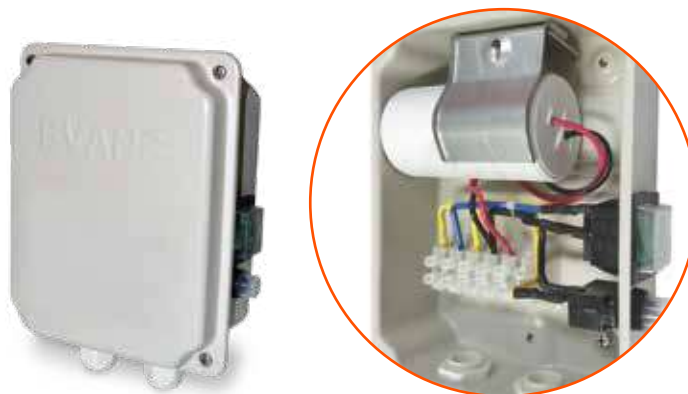

CAJAS DE CONTROL DE UN CAPACITOR PARA BOMBAS SUMERGIBLES

CÓDIGO	POTENCIA	VOLTAJE	CORRIENTE NOMINAL	FACTOR SERVICIO	CORRIENTE MÁXIMA	CAPACITOR
EMCCD.50F-P	1/2 HP	110 V ~ 60Hz 1Φ	6.8 A	1.6	10.9 A	60μF 250VAC
EMCCD.50G-P		220 V ~ 60Hz 1Φ	3.7 A		6 A	20μF 450VAC
EMCCD1.0F-P	1 HP	110 V ~ 60Hz 1Φ	11 A	1.4	15.5 A	100μF 250VAC
EMCCD1.0G-P		220 V ~ 60Hz 1Φ	5.5 A		7.6 A	30μF 450VAC
EMCCD1.5F-P	1.5 HP	110 V ~ 60Hz 1Φ	14.4 A	1.3	18.9 A	120μF 250VAC
EMCCD1.5G-P		220 V ~ 60Hz 1Φ	7.2 A		9.4 A	40μF 450VAC



CAJAS DE CONTROL DE DOBLE CAPACITOR PARA BOMBAS SUMERGIBLES

CÓDIGO	POTENCIA	VOLTAJE	CORRIENTE NOMINAL	FACTOR SERVICIO	CORRIENTE MÁXIMA	CAPACITOR DE ARRANQUE	CAPACITOR DE TRABAJO
EMCCD.50F-P2	1/2 HP	110 V ~ 60Hz 1Φ	6.8 A	1.6	10.9 A	90μF 250VAC	60μF 250VAC
EMCCD.50G-P2		220 V ~ 60Hz 1Φ	3.7 A		6 A	30μF 250VAC	20μF 450VAC
EMCCD1.0F-P2	1 HP	110 V ~ 60Hz 1Φ	11 A	1.4	15.5 A	150μF 250VAC	100μF 250VAC
EMCCD1.0G-P2		220 V ~ 60Hz 1Φ	5.5 A		7.6 A	50μF 250VAC	30μF 450VAC
EMCCD1.5F-P2	1.5 HP	110 V ~ 60Hz 1Φ	14.4 A	1.3	18.9 A	180μF 250VAC	120μF 250VAC
EMCCD1.5G-P2		220 V ~ 60Hz 1Φ	7.2 A		9.4 A	70μF 250VAC	40μF 450VAC
EMCCD2.0G-P2	2 HP	220 V ~ 60Hz 1Φ	9.6 A	1.25	12 A	100μF 250VAC	50μF 450VAC
EMCCD3.0G-P2	3 HP	220 V ~ 60Hz 1Φ	13.6	1.15	15.6	120μF 250VAC	60μF 450VAC
EMCCD5.0G-P2	5 HP	220 V ~ 60Hz 1Φ	22.5 A		25.9 A	160μF 250VAC	80μF 450VAC

Las bombas sumergibles de lapicero sirven para impulsar agua limpia a temperatura ambiente con gran presión, gracias a su sistema de múltiples etapas.

Todas las bombas EVANS® se someten a una detenida verificación, para lograr la satisfacción total del cliente.

- Ideal para extracción de agua de pozos profundos.
- Suministro de agua limpia en granjas, riego agrícola, fábricas, minas, complejos residenciales, industria, etc.
- Resistentes y anti corrosivas por sus materiales en acero inoxidable.

CONSIDERACIONES PARA LA SELECCIÓN DE TU EQUIPO

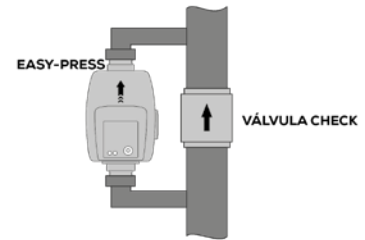

En caso de tuberías mayores de 1", es posible instalar el CONTROL-PRESS o EASY PRESS como "by-pass", conectándolo en paralelo a una tubería de mayor diámetro para no restringir el flujo. Esta instalación es útil para proteger bombas de pozo profundo contra corrida en seco cuando no se tiene acceso al uso de electroneveles.

Para bombas de más de 12 A y/o trifásicas debe conectarlo a la bobina del arrancador.

ALIMENTACIÓN ELÉCTRICA DE LA INSTALACIÓN

FLUJO Y PRESIÓN REQUERIDA PARA LA APLICACIÓN

Toma en cuenta las pérdidas por fricción por accesorios y el diámetro de tubería recomendable de acuerdo al flujo (instala una válvula check cada 50 m de columna de agua).

VÁLVULA ANTI-TORQUE

Elimina el torque generado por el motor para proteger la tubería.

NIVEL DINÁMICO

Velocidad a la que desciende el espejo del agua.

AFORO DEL POZO

Flujo de agua que suministra el pozo.

ADEME DEL POZO

Mínimo 4" para SD4;
Mínimo 6" para SD6;
Mínimo 8" para SD8;

Si el pozo es de mayor diámetro al de la bomba por más de 2", debe instalar la bomba con una camisa de enfriamiento.

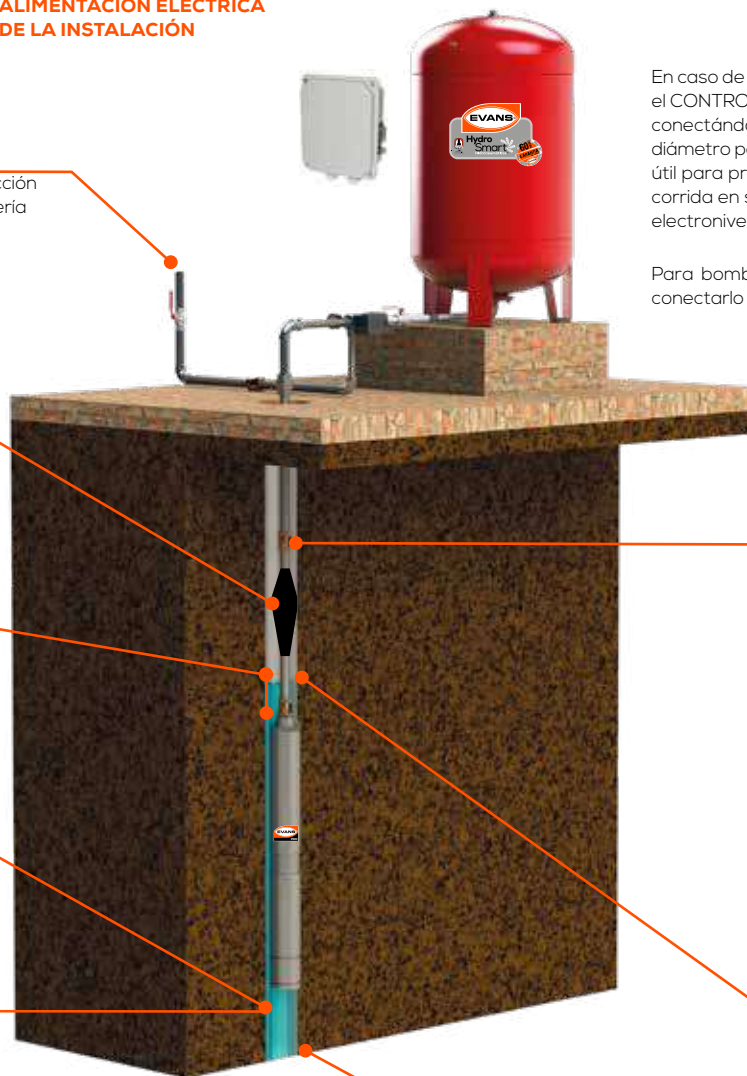

DIÁMETRO DE LA TUBERÍA

Considera el diámetro de la tubería de descarga para instalar una válvula check que puede ser 1 1/4", 2", 3" y 4"

- ABVC125B
- ABVC200B
- ABVC300B
- ABVC400B
- AB-VCS300B
- AB-VCS400B

NIVEL DE ESPEJO DEL AGUA

PROFUNDIDAD DEL POZO

POR SU SEGURIDAD, DEBE ANCLAR LA BOMBA EN LA SUPERFICIE, SUJETÁNDOLA DE LOS EXTREMOS DE LA DESCARGA PARA EVITAR QUE CAIGA AL POZO PROFUNDO.

EQUIPO DE RIEGO SUMERGIBLE 4" | 8 GPM

Desempeño de altura



- La más resistente a la arena en su categoría.
- Impulsores tipo flotantes fabricados en Noryl®.
- Difusores fabricados en policarbonato.
- Descarga y cople en acero inoxidable extra resistentes.
- Válvula check integrada.



BOMBAS SUMERGIBLES

LOS EQUIPOS MONOFÁSICOS INCLUYEN CAJA DE CONTROL METÁLICA HERMÉTICAMENTE SELLADA.

DIAGRAMA DE INSTALACIÓN PARA HIDRONEUMÁTICO

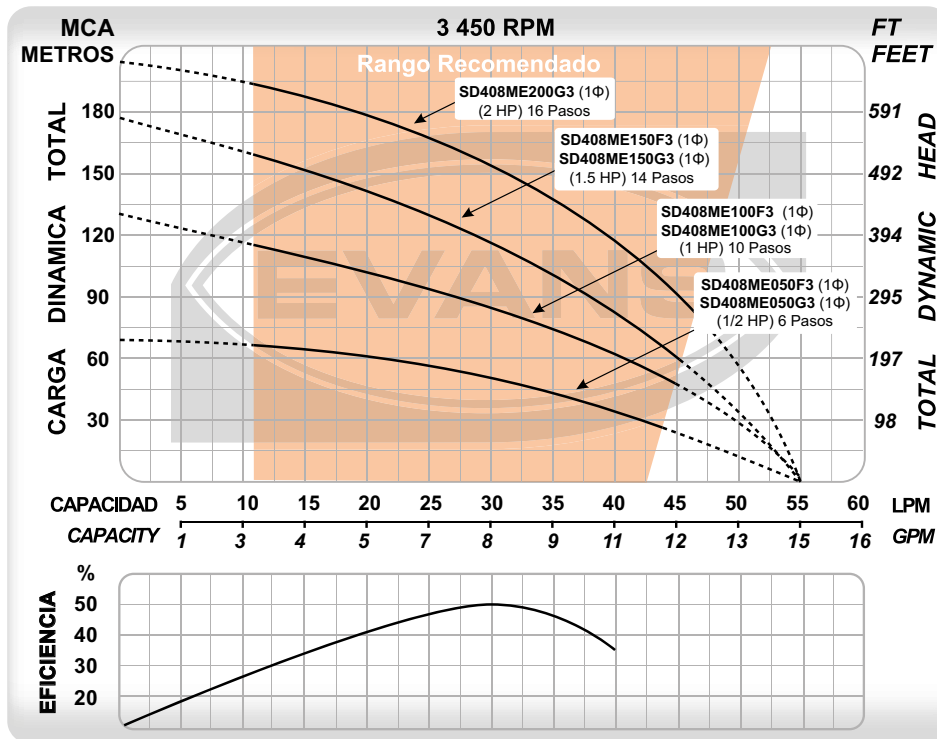

CÓDIGO	PESO	MEDIDAS	
		LARGO X ANCHO X ALTO	
SD408ME050F3	12 kg	75 x 12 x 12 cm	
SD408ME050G3	12 kg	75 x 12 x 12 cm	
SD408ME100F3	14 kg	88 x 12 x 12 cm	
SD408ME100G3	14 kg	88 x 12 x 12 cm	
SD408ME150F3	17 kg	100 x 12 x 12 cm	
SD408ME150G3	17 kg	100 x 12 x 12 cm	
SD408ME200G3	20 kg	106 x 12 x 12 cm	

CÓDIGO	Ø DESCARGA	POTENCIA	VOLTAJE	CORRIENTE	ETAPAS	FLUJO MÁXIMO	PRESIÓN MÁXIMA	PUNTO DE MAYOR EFICIENCIA
SD408ME050F3	1 ¼"	1/2 HP	110 V ~ 60Hz 1Φ	10.9 A	6	55 l/min	74 m	30 l/min a 50 m
SD408ME050G3	1 ¼"	1/2 HP	220 V ~ 60Hz 1Φ	6 A	6	55 l/min	74 m	30 l/min a 50 m
SD408ME100F3	1 ¼"	1 HP	110 V ~ 60Hz 1Φ	15.5 A	10	55 l/min	125 m	30 l/min a 83 m
SD408ME100G3	1 ¼"	1 HP	220 V ~ 60Hz 1Φ	7.6 A	10	55 l/min	125 m	30 l/min a 83 m
SD408ME150F3	1 ¼"	1.5 HP	110 V ~ 60Hz 1Φ	18.9 A	14	55 l/min	176 m	30 l/min a 118 m
SD408ME150G3	1 ¼"	1.5 HP	220 V ~ 60Hz 1Φ	9.4 A	14	55 l/min	176 m	30 l/min a 118 m
SD408ME200G3	1 ¼"	2 HP	220 V ~ 60Hz 1Φ	12 A	16	55 l/min	203 m	30 l/min a 154 m



CLASE IH

EQUIPO DE RIEGO SUMERGIBLE 4" | 8 GPM

Desempeño de altura

BOMBAS SUMERGIBLES



- La más resistente a la arena en su categoría.
- Impulsores tipo flotantes fabricados en Noryl®.
- Difusores fabricados en policarbonato.
- Descarga y cople en acero inoxidable extra resistentes.
- Válvula check integrada.

DIAGRAMA DE INSTALACIÓN PARA HIDRONEUMÁTICO

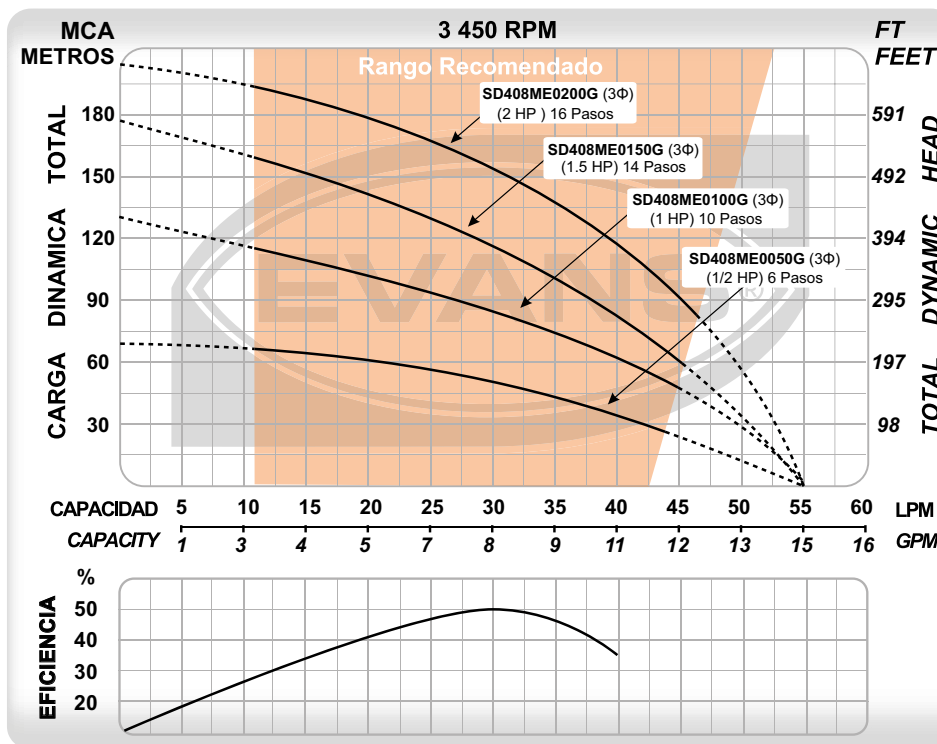

CÓDIGO	PESO	MEDIDAS LARGO X ANCHO X ALTO
SD408ME0050G	11.4 kg	79 x 12 x 12 cm
SD408ME0100G	14 kg	90 x 12 x 12 cm
SD408ME0150G	15.5 kg	100 x 12 x 12 cm
SD408ME0200G	19 kg	106 x 12 x 12 cm

CÓDIGO	Ø DESCARGA	POTENCIA	VOLTAJE	CORRIENTE	ETAPAS	FLUJO MÁXIMO	PRESIÓN MÁXIMA	PUNTO DE MAYOR EFICIENCIA
SD408ME0050G	1 ¼"	1/2 HP	220 V ~ 60Hz 3Φ	3.4 A	6	55 l/min	74 m	30 l/min a 50 m
SD408ME0100G	1 ¼"	1 HP	220 V ~ 60Hz 3Φ	5.5 A	10	55 l/min	125 m	30 l/min a 83 m
SD408ME0150G	1 ¼"	1.5 HP	220 V ~ 60Hz 3Φ	6.4 A	14	55 l/min	176 m	30 l/min a 118 m
SD408ME0200G	1 ¼"	2 HP	220 V ~ 60Hz 3Φ	8.2 A	16	55 l/min	203 m	30 l/min a 154 m

EQUIPO DE RIEGO SUMERGIBLE 4" | 8 GPM

Desempeño de altura



- La más resistente a la arena en su categoría.
- Impulsores tipo flotantes fabricados en Noryl®.
- Difusores fabricados en policarbonato.
- Descarga y cople en acero inoxidable extra resistentes.
- Válvula check integrada.



BOMBAS SUMERGIBLES

LOS EQUIPOS MONOFÁSICOS INCLUYEN CAJA DE CONTROL METÁLICA HERMÉTICAMENTE SELLADA.

DIAGRAMA DE INSTALACIÓN PARA HIDRONEUMÁTICO

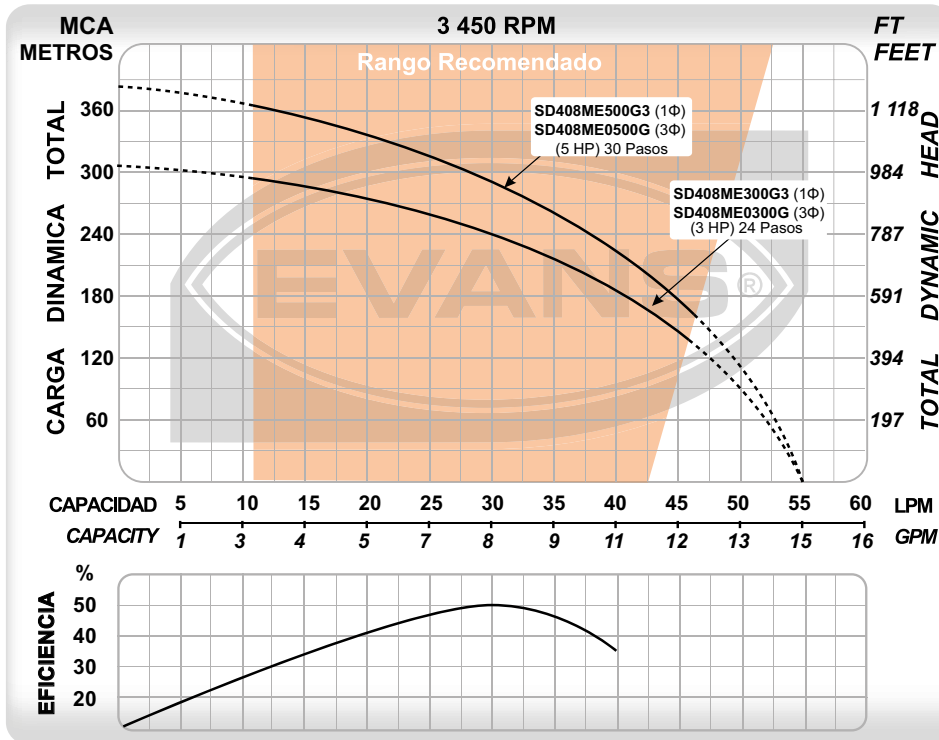

CÓDIGO	PESO	MEDIDAS
		LARGO X ANCHO X ALTO
SD408ME300G3	25 kg	128 x 12 x 12 cm
SD408ME0300G	25 kg	128 x 12 x 12 cm
SD408ME500G3	42 kg	175 x 26 x 33 cm
SD408ME0500G	42 kg	175 x 26 x 33 cm

CÓDIGO	Ø DESCARGA	POTENCIA	VOLTAJE	CORRIENTE	ETAPAS	FLUJO MÁXIMO	PRESIÓN MÁXIMA	PUNTO DE MAYOR EFICIENCIA
SD408ME300G3	1 ¼"	3 HP	220 V ~ 60Hz 1Φ	15.6 A	24	55 l/min	304 m	30 l/min a 240 m
SD408ME0300G	1 ¼"	3 HP	220 V ~ 60Hz 3Φ	10.9 A	24	55 l/min	304 m	30 l/min a 240 m
SD408ME500G3	1 ¼"	5 HP	220 V ~ 60Hz 1Φ	25.9 A	30	55 l/min	381 m	30 l/min a 288 m
SD408ME0500G	1 ¼"	5 HP	220 V ~ 60Hz 3Φ	17.3 A	30	55 l/min	381 m	30 l/min a 288 m



CLASE 1H

EQUIPO DE RIEGO SUMERGIBLE INOX. 4" | 10 GPM

Desempeño de altura

BOMBAS SUMERGIBLES



- La mejor eficiencia y desempeño en su categoría.
- Impulsores y difusores fabricados en acero inoxidable 304.
- Válvula check integrada.



LOS EQUIPOS MONOFÁSICOS INCLUYEN CAJA DE CONTROL METÁLICA HERMÉTICAMENTE SELLADA.

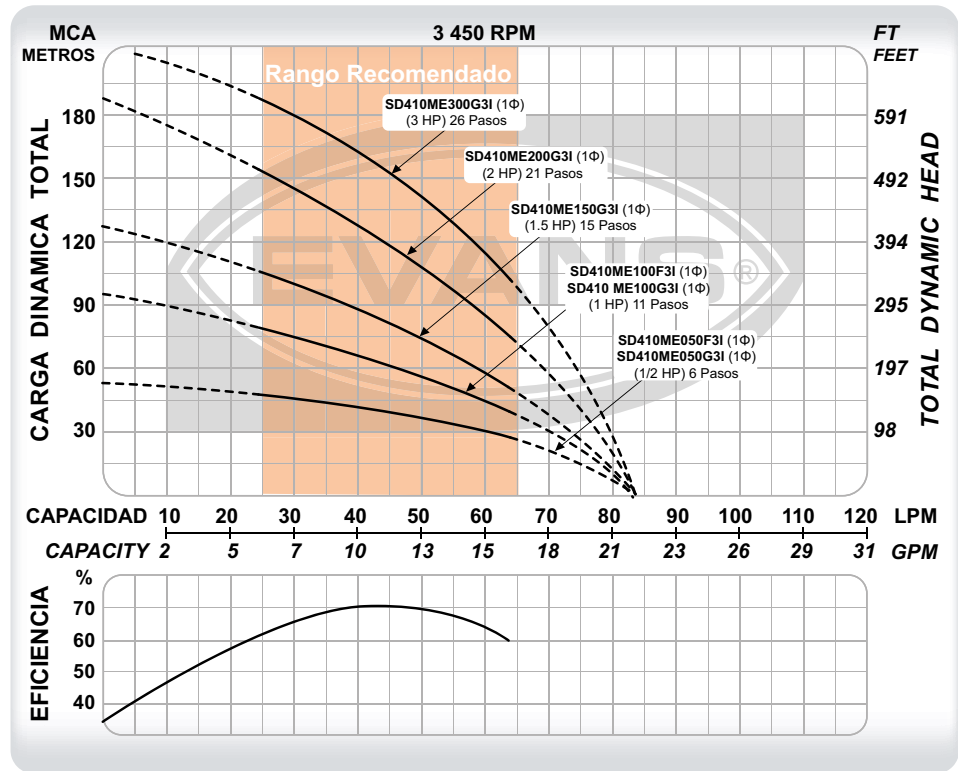

CÓDIGO	PESO	MEDIDAS
		LARGO X ANCHO X ALTO
SD410ME050F31	11.5 kg	79 x 12 x 12 cm
SD410ME050G31	11.5 kg	79 x 12 x 12 cm
SD410ME100F31	15 kg	94 x 12 x 12 cm
SD410ME100G31	14.5 kg	94 x 12 x 12 cm
SD410ME150G31	16.5 kg	105 x 12 x 12 cm
SD410ME200G31	19.5 kg	122 x 12 x 12 cm
SD410ME300G31	23.5 kg	137 x 12 x 12 cm

CÓDIGO	Ø DESCARGA	POTENCIA	VOLTAJE	CORRIENTE	ETAPAS	FLUJO MÁXIMO	PRESIÓN MÁXIMA	PUNTO DE MAYOR EFICIENCIA
SD410ME050F31	1 ¼"	1/2 HP	110 V ~ 60Hz 1Φ	10.9 A	6	85 l/min	55 m	45 l/min a 37 m
SD410ME050G31	1 ¼"	1/2 HP	220 V ~ 60Hz 1Φ	6 A	6	85 l/min	55 m	45 l/min a 37 m
SD410ME100F31	1 ¼"	1 HP	110 V ~ 60Hz 1Φ	15.5 A	11	85 l/min	97 m	45 l/min a 65 m
SD410ME100G31	1 ¼"	1 HP	220 V ~ 60Hz 1Φ	7.6 A	11	85 l/min	97 m	45 l/min a 65 m
SD410ME150G31	1 ¼"	1.5 HP	220 V ~ 60Hz 1Φ	9.4 A	15	85 l/min	130 m	45 l/min a 84 m
SD410ME200G31	1 ¼"	2 HP	220 V ~ 60Hz 1Φ	12 A	21	85 l/min	187 m	45 l/min a 121 m
SD410ME300G31	1 ¼"	3 HP	220 V ~ 60Hz 1Φ	15.6 A	26	85 l/min	231 m	45 l/min a 154 m

EQUIPO DE RIEGO SUMERGIBLE INOX. 4" | 10 GPM

Desempeño de altura

CLASE 1H



- La mejor eficiencia y desempeño en su categoría.
- Impulsores y difusores fabricados en acero inoxidable 304.
- Válvula check integrada.



BOMBAS SUMERGIBLES

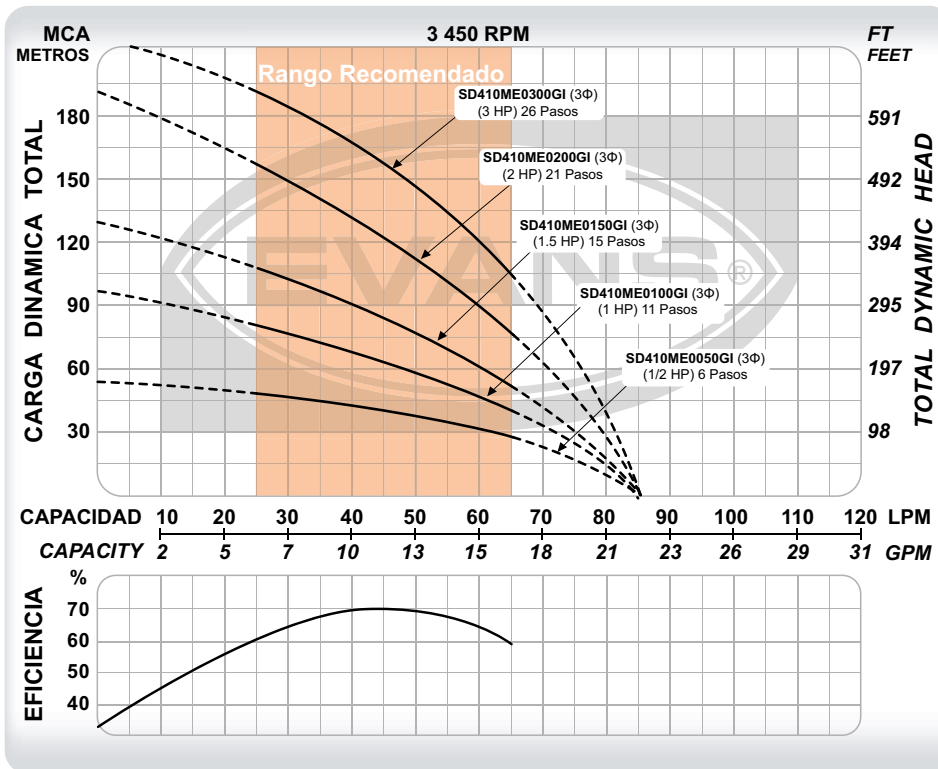

CÓDIGO	PESO	MEDIDAS LARGO X ANCHO X ALTO
SD410ME0050GI	10.5 kg	84 x 12 x 12 cm
SD410ME0100GI	14 kg	98 x 12 x 12 cm
SD410ME0150GI	16 kg	109 x 12 x 12 cm
SD410ME0200GI	19 kg	122 x 12 x 12 cm
SD410ME0300GI	23 kg	139 x 12 x 12 cm
SD410ME200G3I	19.5 kg	122 x 12 x 12 cm
SD410ME300G3I	23.5 kg	137 x 12 x 12 cm

CÓDIGO	Ø DESCARGA	POTENCIA	VOLTAJE	CORRIENTE	ETAPAS	FLUJO MÁXIMO	PRESIÓN MÁXIMA	PUNTO DE MAYOR EFICIENCIA
SD410ME0050GI	1 ¼"	1/2 HP	220 V ~ 60Hz 3Φ	3.4 A	6	85 l/min	55 m	45 l/min a 37 m
SD410ME0100GI	1 ¼"	1 HP	220 V ~ 60Hz 3Φ	5.5 A	11	85 l/min	97 m	45 l/min a 65 m
SD410ME0150GI	1 ¼"	1.5 HP	220 V ~ 60Hz 3Φ	6.4 A	15	85 l/min	130 m	45 l/min a 84 m
SD410ME0200GI	1 ¼"	2 HP	220 V ~ 60Hz 3Φ	8.2 A	21	85 l/min	187 m	45 l/min a 121 m
SD410ME0300GI	1 ¼"	3 HP	220 V ~ 60Hz 3Φ	10.9 A	26	85 l/min	231 m	45 l/min a 154 m



CLASE 1H

EQUIPO DE RIEGO SUMERGIBLE 4" | 16 GPM

Desempeño de altura

BOMBAS SUMERGIBLES



- La más resistente a la arena en su categoría.
- Impulsores tipo flotantes fabricados en Noryl®.
- Difusores fabricados en policarbonato.
- Descarga y cople en acero inoxidable extra resistentes.
- Válvula check integrada.

LOS EQUIPOS MONOFÁSICOS INCLUYEN CAJA DE CONTROL METÁLICA HERMÉTICAMENTE SELLADA.

CÓDIGO	PESO	MEDIDAS
		LARGO X ANCHO X ALTO
SD416ME050F3	11 kg	70 x 12 x 12 cm
SD416ME050G3	11 kg	70 x 12 x 12 cm
SD416ME100F3	15 kg	85 x 12 x 12 cm
SD416ME100G3	15 kg	85 x 12 x 12 cm
SD416ME150F3	16 kg	95 x 12 x 12 cm
SD416ME150G3	16 kg	95 x 12 x 12 cm
SD416ME200G3	15.5 kg	110 x 12 x 12 cm
SD416ME300G3	22 kg	130 x 12 x 12 cm

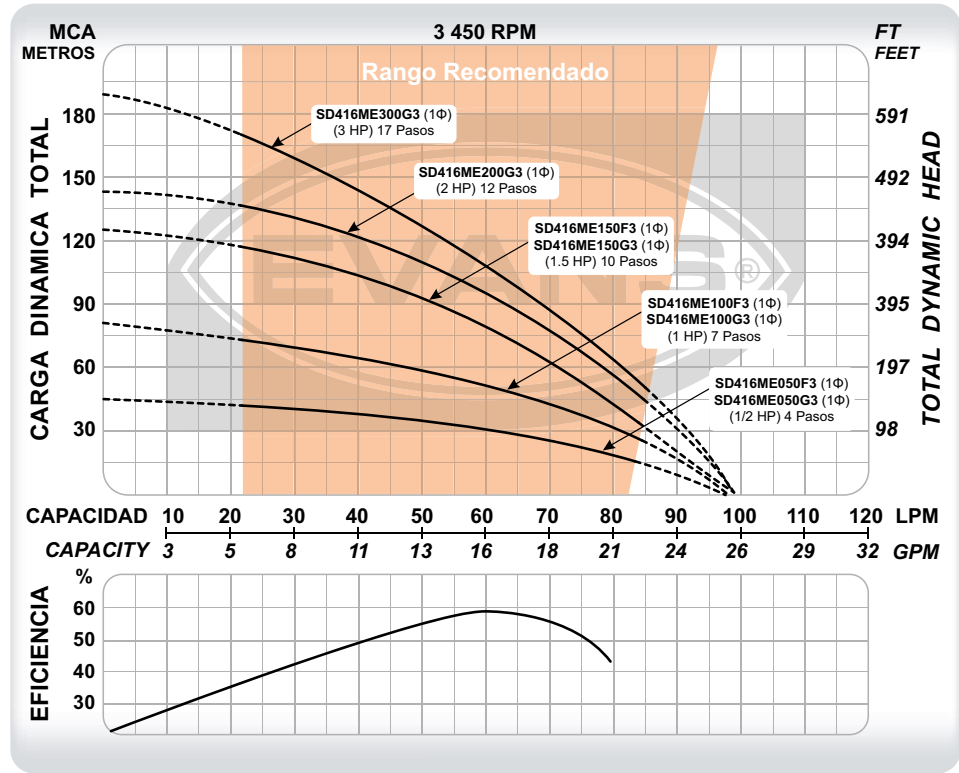

CÓDIGO	Ø DESCARGA	POTENCIA	VOLTAJE	CORRIENTE	ETAPAS	FLUJO MÁXIMO	PRESIÓN MÁXIMA	PUNTO DE MAYOR EFICIENCIA
SD416ME050F3	1 ¼"	1/2 HP	110 V ~ 60Hz 1Φ	10.9 A	4	98 l/min	45 m	60 l/min a 32 m
SD416ME050G3	1 ¼"	1/2 HP	220 V ~ 60Hz 1Φ	6 A	4	98 l/min	45 m	60 l/min a 32 m
SD416ME100F3	1 ¼"	1 HP	110 V ~ 60Hz 1Φ	15.5 A	7	98 l/min	81 m	60 l/min a 53 m
SD416ME100G3	1 ¼"	1 HP	220 V ~ 60Hz 1Φ	7.6 A	7	98 l/min	81 m	60 l/min a 53 m
SD416ME150F3	1 ¼"	1.5 HP	110 V ~ 60Hz 1Φ	18.9 A	10	98 l/min	122 m	60 l/min a 80 m
SD416ME150G3	1 ¼"	1.5 HP	220 V ~ 60Hz 1Φ	9.4 A	10	98 l/min	122 m	60 l/min a 80 m
SD416ME200G3	1 ¼"	2 HP	220 V ~ 60Hz 1Φ	12 A	12	98 l/min	145 m	60 l/min a 95 m
SD416ME300G3	1 ¼"	3 HP	220 V ~ 60Hz 1Φ	15.6 A	17	98 l/min	190 m	60 l/min a 105 m

EQUIPO DE RIEGO SUMERGIBLE 4" | 16 GPM

Desempeño de altura

CLASE 1H



- La más resistente a la arena en su categoría.
- Impulsores tipo flotantes fabricados en Noryl®.
- Difusores fabricados en policarbonato.
- Descarga y cople en acero inoxidable extra resistentes.
- Válvula check integrada.



BOMBAS SUMERGIBLES

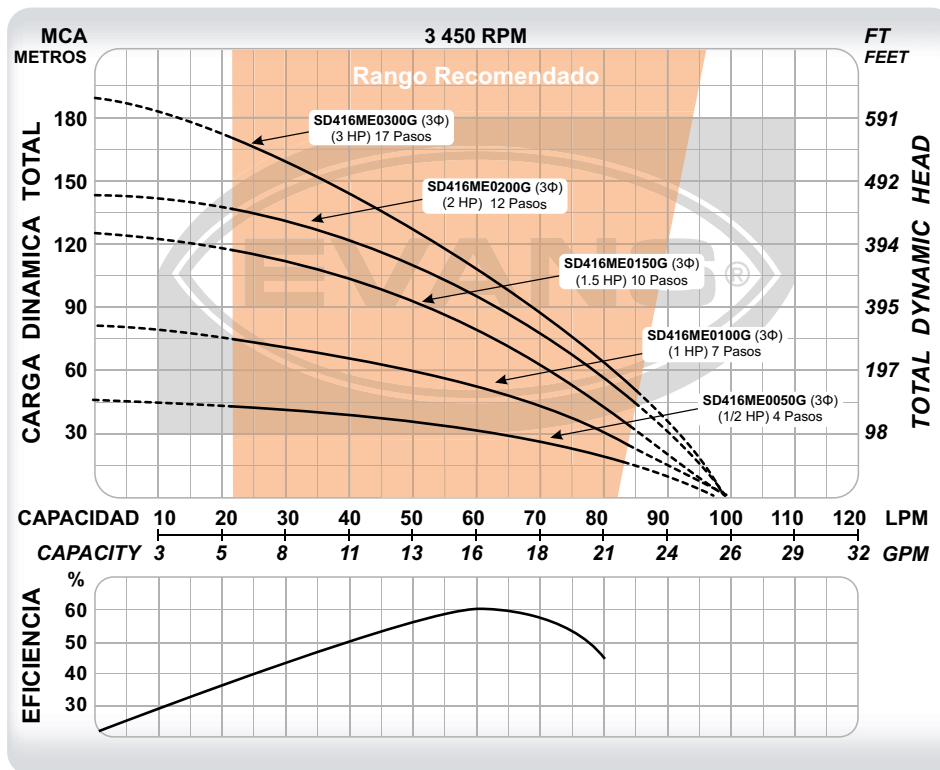

CÓDIGO	PESO	MEDIDAS LARGO X ANCHO X ALTO
SD416ME0050G	10 kg	70 x 12 x 12 cm
SD416ME0100G	14 kg	85 x 12 x 12 cm
SD416ME0150G	16 kg	95 x 12 x 12 cm
SD416ME0200G	18 kg	110 x 12 x 12 cm
SD416ME0300G	21 kg	130 x 12 x 12 cm

CÓDIGO	Ø DESCARGA	POTENCIA	VOLTAJE	CORRIENTE	ETAPAS	FLUJO MÁXIMO	PRESIÓN MÁXIMA	PUNTO DE MAYOR EFICIENCIA
SD416ME0050G	1 ¼"	1/2 HP	220 V ~ 60Hz 3Φ	3.4 A	4	98 l/min	45 m	60 l/min a 32 m
SD416ME0100G	1 ¼"	1 HP	220 V ~ 60Hz 3Φ	5.5 A	7	98 l/min	81 m	60 l/min a 53 m
SD416ME0150G	1 ¼"	1.5 HP	220 V ~ 60Hz 3Φ	6.4 A	10	98 l/min	122 m	60 l/min a 80 m
SD416ME0200G	1 ¼"	2 HP	220 V ~ 60Hz 3Φ	8.2 A	12	98 l/min	145 m	60 l/min a 95 m
SD416ME0300G	1 ¼"	3 HP	220 V ~ 60Hz 3Φ	10.7 A	17	98 l/min	190 m	60 l/min a 105 m



CLASE IH

EQUIPO DE RIEGO SUMERGIBLE 4" | 16 GPM

Desempeño de altura

BOMBAS SUMERGIBLES



- La más resistente a la arena en su categoría.
- Impulsores tipo flotantes fabricados en Noryl®.
- Difusores fabricados en policarbonato.
- Descarga y cople en acero inoxidable extra resistentes.
- Válvula check integrada.



LOS EQUIPOS MONOFÁSICOS INCLUYEN CAJA DE CONTROL METÁLICA HERMÉTICAMENTE SELLADA.

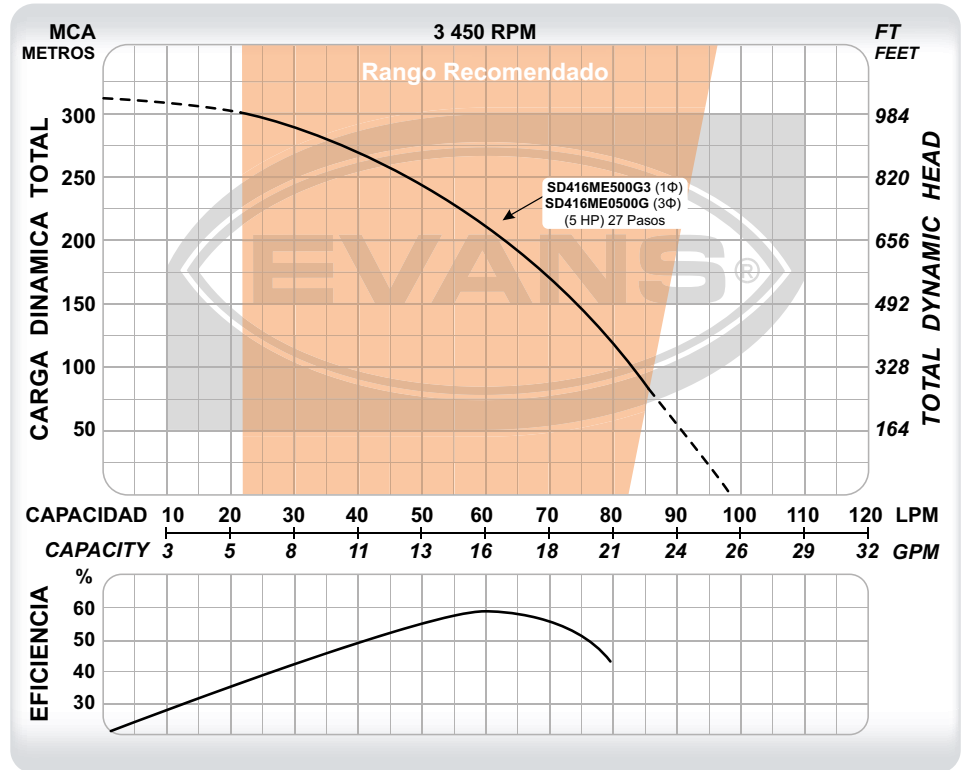

CÓDIGO	PESO	MEDIDAS LARGO X ANCHO X ALTO
SD416ME500G3	41 kg	165 x 26 x 33 cm
SD416ME0500G	41 kg	165 x 26 x 33 cm

CÓDIGO	Ø DESCARGA	POTENCIA	VOLTAJE	CORRIENTE	ETAPAS	FLUJO MÁXIMO	PRESIÓN MÁXIMA	PUNTO DE MAYOR EFICIENCIA
SD416ME500G3	1 ¼"	5 HP	220 V ~ 60Hz 1Φ	25.9 A	27	98 l/min	310 m	60 l/min a 210 m
SD416ME0500G	1 ¼"	5 HP	220 V ~ 60Hz 3Φ	17.3 A	27	98 l/min	310 m	60 l/min a 210 m

EQUIPO DE RIEGO SUMERGIBLE INOX. 4" | 18 GPM

Desempeño de altura

CLASE 1H



- La mejor eficiencia y desempeño en su categoría.
- Impulsores y difusores fabricados en acero inoxidable 304.
- Válvula check integrada.



BOMBAS SUMERGIBLES

LOS EQUIPOS MONOFÁSICOS INCLUYEN CAJA DE CONTROL METÁLICA HERMÉTICAMENTE SELLADA.

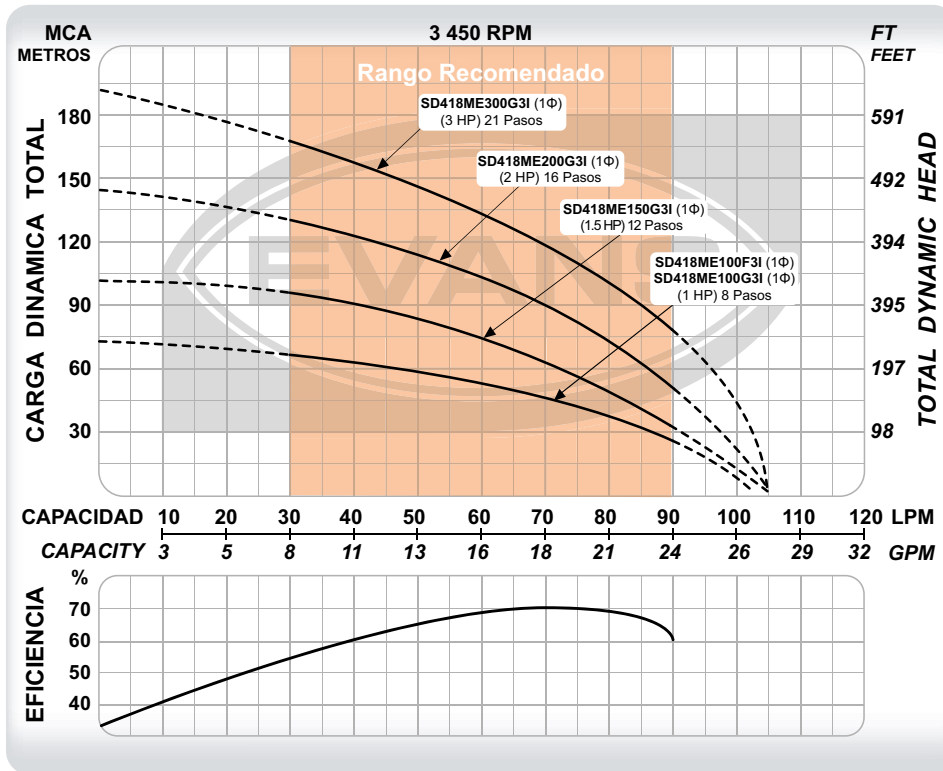

CÓDIGO	PESO	MEDIDAS LARGO X ANCHO X ALTO
SD418ME100F3I	14 kg	88 x 12 x 12 cm
SD418ME100G3I	14 kg	88 x 12 x 12 cm
SD418ME150G3I	16 kg	99 x 12 x 12 cm
SD418ME200G3I	18.5 kg	112 x 12 x 12 cm
SD418ME300G3I	22 kg	127 x 12 x 12 cm

CÓDIGO	Ø DESCARGA	POTENCIA	VOLTAJE	CORRIENTE	ETAPAS	FLUJO MÁXIMO	PRESIÓN MÁXIMA	PUNTO DE MAYOR EFICIENCIA
SD418ME100F3I	1 ¼"	1 HP	110 V ~ 60Hz 1Φ	15.5 A	8	105 l/min	73 m	70 l/min a 45 m
SD418ME100G3I	1 ¼"	1 HP	220 V ~ 60Hz 1Φ	7.6 A	8	105 l/min	73 m	70 l/min a 45 m
SD418ME150G3I	1 ¼"	1.5 HP	220 V ~ 60Hz 1Φ	9.4 A	12	105 l/min	105 m	70 l/min a 62 m
SD418ME200G3I	1 ¼"	2 HP	220 V ~ 60Hz 1Φ	12 A	16	105 l/min	146 m	70 l/min a 90 m
SD418ME300G3I	1 ¼"	3 HP	220 V ~ 60Hz 1Φ	15.6 A	21	105 l/min	190 m	70 l/min a 119 m



CLASE IH

EQUIPO DE RIEGO SUMERGIBLE INOX. 4" | 18 GPM

Desempeño de altura

BOMBAS SUMERGIBLES



- La mejor eficiencia y desempeño en su categoría.
- Impulsores y difusores fabricados en acero inoxidable 304.
- Válvula check integrada.



CÓDIGO	PESO	MEDIDAS
		LARGO X ANCHO X ALTO
SD418ME0100GI	13.5 kg	95 x 12 x 12 cm
SD418ME0150GI	16 kg	102 x 12 x 12 cm
SD418ME0200GI	18.5 kg	112 x 12 x 12 cm
SD418ME0300GI	21.5 kg	126 x 12 x 12 cm

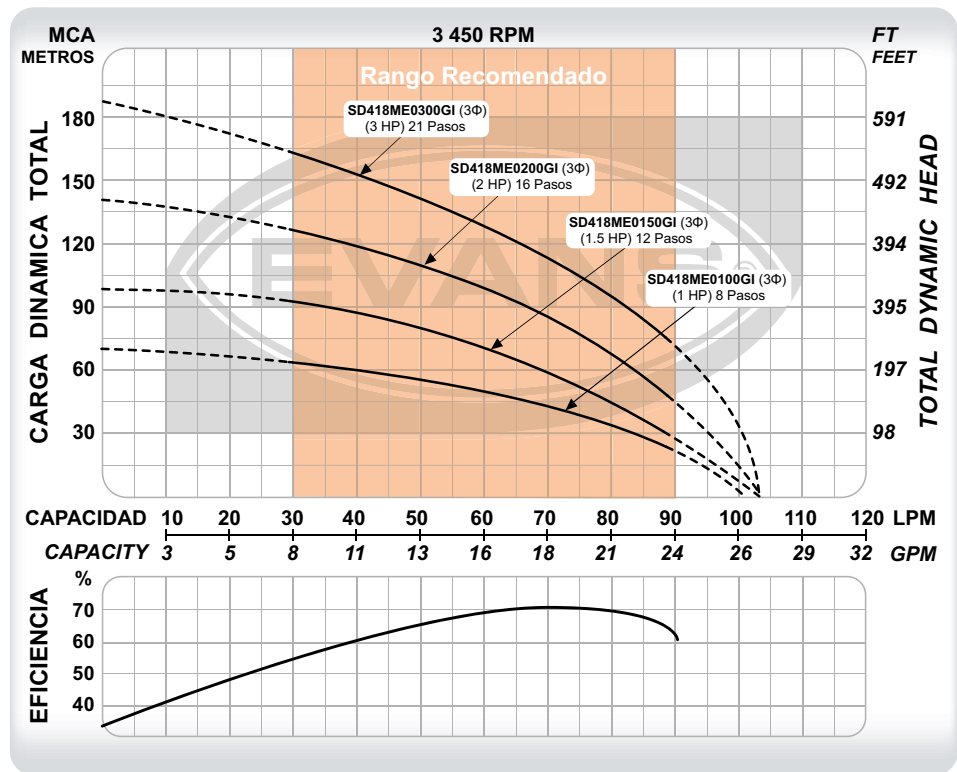

CÓDIGO	Ø DESCARGA	POTENCIA	VOLTAJE	CORRIENTE	ETAPAS	FLUJO MÁXIMO	PRESIÓN MÁXIMA	PUNTO DE MAYOR EFICIENCIA
SD418ME0100GI	1 ¼"	1 HP	220 V ~ 60Hz 3Φ	5.5 A	8	105 l/min	73 m	70 l/min a 45 m
SD418ME0150GI	1 ¼"	1.5 HP	220 V ~ 60Hz 3Φ	6.4 A	12	105 l/min	105 m	70 l/min a 62 m
SD418ME0200GI	1 ¼"	2 HP	220 V ~ 60Hz 3Φ	8.2 A	16	105 l/min	146 m	70 l/min a 90 m
SD418ME0300GI	1 ¼"	3 HP	220 V ~ 60Hz 3Φ	10.9 A	21	105 l/min	190 m	70 l/min a 119 m

EQUIPO DE RIEGO SUMERGIBLE INOX. 4" | 18 GPM

Desempeño de altura

CLASE 1H



- La mejor eficiencia y desempeño en su categoría.
- Impulsores y difusores fabricados en acero inoxidable 304.
- Válvula check integrada.



BOMBAS SUMERGIBLES

LOS EQUIPOS MONOFÁSICOS INCLUYEN CAJA DE CONTROL METÁLICA HERMÉTICAMENTE SELLADA.

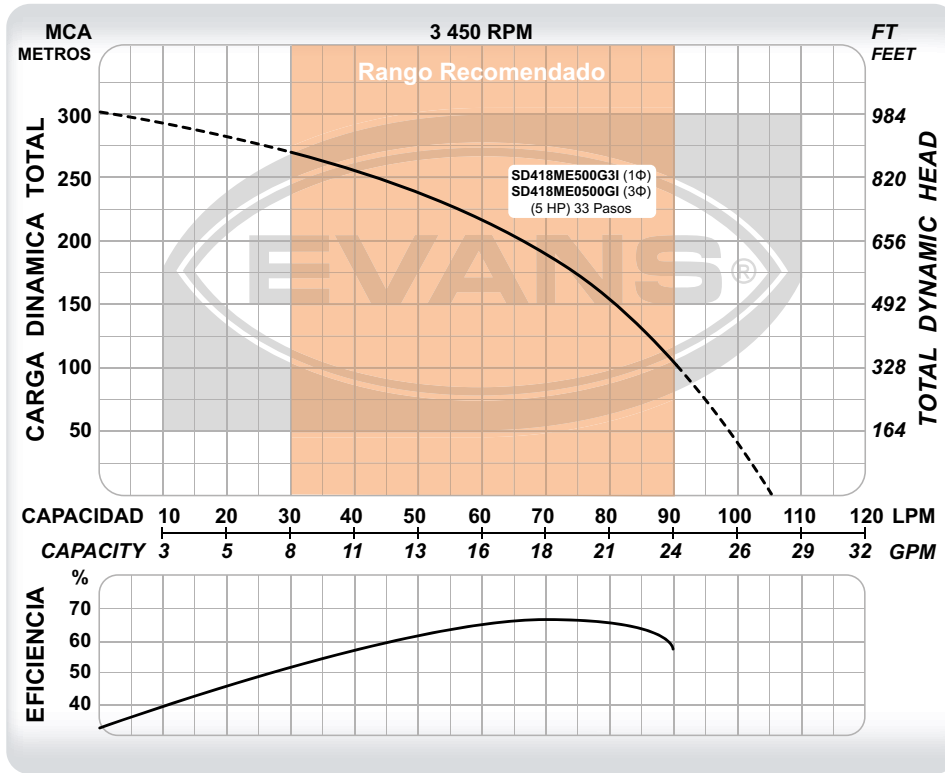

CÓDIGO	PESO	MEDIDAS LARGO X ANCHO X ALTO
SD418ME500G3I	32.5 kg	166 x 26 x 33 cm
SD418ME0500GI	33.5 kg	166 x 26 x 33 cm

CÓDIGO	Ø DESCARGA	POTENCIA	VOLTAJE	CORRIENTE	ETAPAS	FLUJO MÁXIMO	PRESIÓN MÁXIMA	PUNTO DE MAYOR EFICIENCIA
SD418ME500G3I	1 ¼"	5 HP	220 V ~ 60Hz 1Φ	25.9 A	33	105 l/min	300 m	70 l/min a 188 m
SD418ME0500GI	1 ¼"	5 HP	220 V ~ 60Hz 3Φ	17.3 A	33	105 l/min	300 m	70 l/min a 188 m

DEBIDO A LAS MEJORAS CONSTANTES, EL PRODUCTO PUEDE VARIAR EN SU APARIENCIA. ESPECIFICACIONES SUJETAS A CAMBIO SIN PREVIO AVISO.



CLASE IH

EQUIPO DE RIEGO SUMERGIBLE 4" | 25 GPM

Desempeño de altura

BOMBAS SUMERGIBLES



- La más resistente a la arena en su categoría.
- Impulsores tipo flotantes fabricados en Noryl®.
- Difusores fabricados en policarbonato.
- Descarga y cople en acero inoxidable extra resistentes.
- Válvula check integrada.



LOS EQUIPOS MONOFÁSICOS INCLUYEN CAJA DE CONTROL METÁLICA HERMÉTICAMENTE SELLADA.

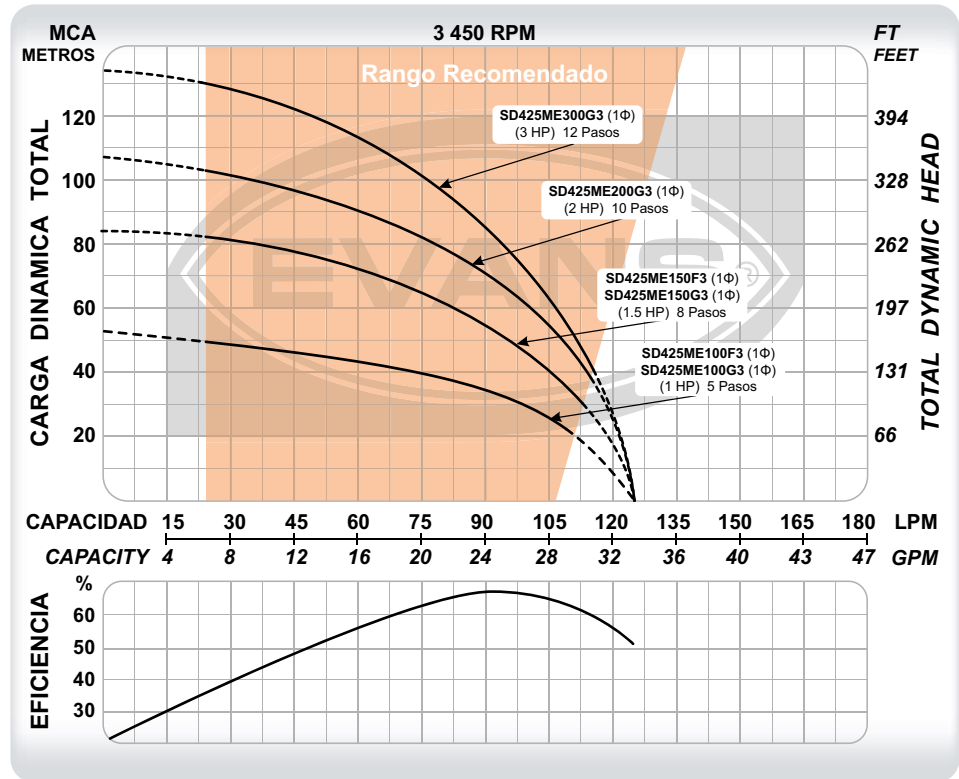

CÓDIGO	PESO	MEDIDAS
		LARGO X ANCHO X ALTO
SD425ME100F3	14 kg	85 x 12 x 12 cm
SD425ME100G3	14 kg	85 x 12 x 12 cm
SD425ME150F3	16 kg	95 x 12 x 12 cm
SD425ME150G3	16 kg	95 x 12 x 12 cm
SD425ME200G3	18 kg	110 x 12 x 12 cm
SD425ME300G3	20 kg	115 x 12 x 12 cm

CÓDIGO	Ø DESCARGA	POTENCIA	VOLTAJE	CORRIENTE	ETAPAS	FLUJO MÁXIMO	PRESIÓN MÁXIMA	PUNTO DE MAYOR EFICIENCIA
SD425ME100F3	2"	1 HP	110 V ~ 60Hz 1Φ	15.5 A	5	125 l/min	52 m	90 l/min a 32 m
SD425ME100G3	2"	1 HP	220 V ~ 60Hz 1Φ	7.6 A	5	125 l/min	52 m	90 l/min a 32 m
SD425ME150F3	2"	1.5 HP	110 V ~ 60Hz 1Φ	18.9 A	8	125 l/min	83 m	90 l/min a 55 m
SD425ME150G3	2"	1.5 HP	220 V ~ 60Hz 1Φ	9.4 A	8	125 l/min	83 m	90 l/min a 55 m
SD425ME200G3	2"	2 HP	220 V ~ 60Hz 1Φ	12 A	10	125 l/min	109 m	90 l/min a 71 m
SD425ME300G3	2"	3 HP	220 V ~ 60Hz 1Φ	15.6 A	12	125 l/min	132 m	90 l/min a 85 m

EQUIPO DE RIEGO SUMERGIBLE 4" | 25 GPM

Desempeño de altura

CLASE 1H



- La más resistente a la arena en su categoría.
- Impulsores tipo flotantes fabricados en Noryl®.
- Difusores fabricados en policarbonato.
- Descarga y cople en acero inoxidable extra resistentes.
- Válvula check integrada.



BOMBAS SUMERGIBLES

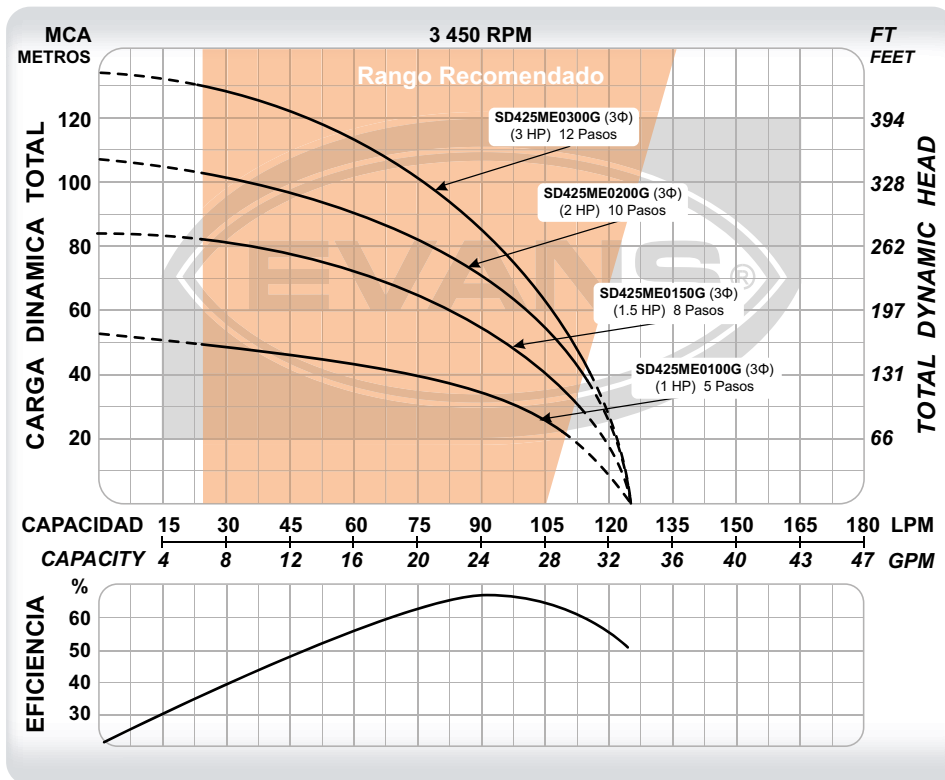

CÓDIGO	PESO	MEDIDAS
		LARGO X ANCHO X ALTO
SD425ME0100G	13 kg	85 x 12 x 12 cm
SD425ME0150G	16 kg	95 x 12 x 12 cm
SD425ME0200G	18 kg	106 x 12 x 12 cm
SD425ME0300G	20 kg	120 x 12 x 12 cm

CÓDIGO	Ø DESCARGA	POTENCIA	VOLTAJE	CORRIENTE	ETAPAS	FLUJO MÁXIMO	PRESIÓN MÁXIMA	PUNTO DE MAYOR EFICIENCIA
SD425ME0100G	2"	1 HP	220 V ~ 60Hz 3Φ	5.5 A	5	125 l/min	52 m	90 l/min a 32 m
SD425ME0150G	2"	1.5 HP	220 V ~ 60Hz 3Φ	6.4 A	8	125 l/min	83 m	90 l/min a 55 m
SD425ME0200G	2"	2 HP	220 V ~ 60Hz 3Φ	8.2 A	10	125 l/min	109 m	90 l/min a 71 m
SD425ME0300G	2"	3 HP	220 V ~ 60Hz 3Φ	10.9 A	12	125 l/min	132 m	90 l/min a 85 m



CLASE IH

EQUIPO DE RIEGO SUMERGIBLE 4" | 25 GPM

Desempeño de altura

BOMBAS SUMERGIBLES



- La más resistente a la arena en su categoría.
- Impulsores tipo flotantes fabricados en Noryl®.
- Difusores fabricados en policarbonato.
- Descarga y cople en acero inoxidable extra resistentes.
- Válvula check integrada.



LOS EQUIPOS MONOFÁSICOS INCLUYEN CAJA DE CONTROL METÁLICA HERMÉTICAMENTE SELLADA.

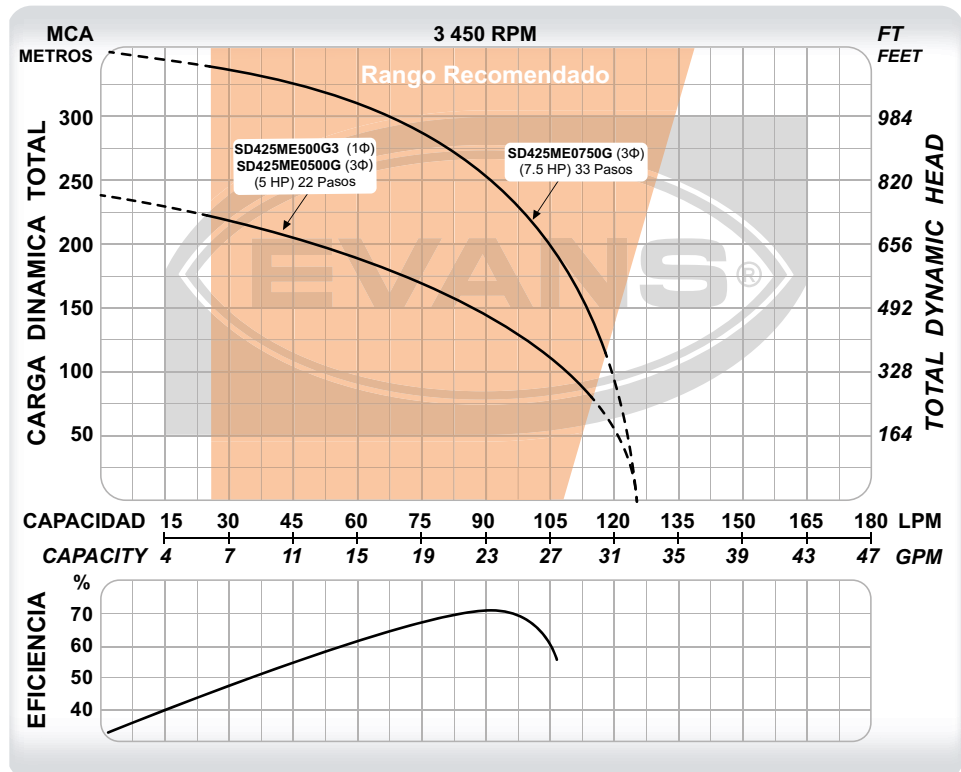

CÓDIGO	PESO	MEDIDAS LARGO X ANCHO X ALTO
SD425ME500G3	30 kg	165 x 26 x 33 cm
SD425ME0500G	29 kg	165 x 26 x 33 cm
SD425ME0750G	49 kg	222 x 26 x 33 cm

CÓDIGO	Ø DESCARGA	POTENCIA	VOLTAJE	CORRIENTE	ETAPAS	FLUJO MÁXIMO	PRESIÓN MÁXIMA	PUNTO DE MAYOR EFICIENCIA
SD425ME500G3	2"	5 HP	220 V ~ 60Hz 1Φ	25.9 A	22	125 l/min	238 m	90 l/min a 141 m
SD425ME0500G	2"	5 HP	220 V ~ 60Hz 3Φ	17.3 A	22	125 l/min	238 m	90 l/min a 141 m
SD425ME0750G	2"	7.5 HP	220 V ~ 60Hz 3Φ	25.9 A	33	125 l/min	350 m	90 l/min a 250 m

EQUIPO DE RIEGO SUMERGIBLE INOX. 4" | 25 GPM

Desempeño de altura

CLASE 1H



- La mejor eficiencia y desempeño en su categoría.
- Impulsores y difusores fabricados en acero inoxidable 304.
- Válvula check integrada.



BOMBAS SUMERGIBLES



LOS EQUIPOS MONOFÁSICOS INCLUYEN CAJA DE CONTROL METÁLICA HERMÉTICAMENTE SELLADA.

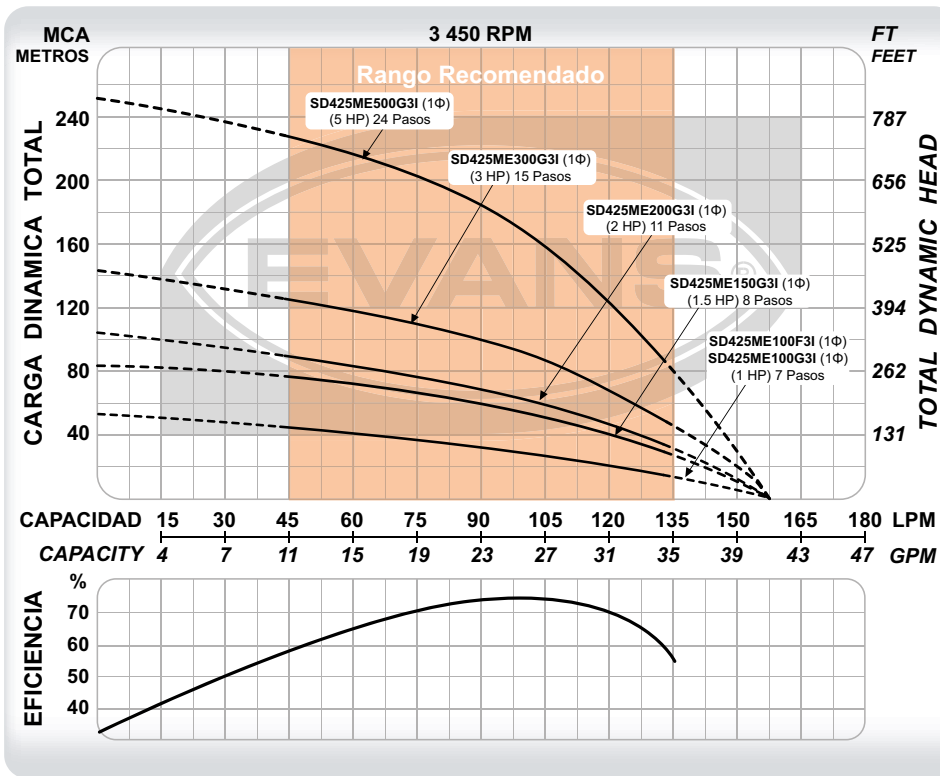

CÓDIGO	PESO	MEDIDAS	
		LARGO X ANCHO X ALTO	
SD425ME100F3I	14 kg	85 x 12 x 12 cm	
SD425ME100G3I	14 kg	85 x 12 x 12 cm	
SD425ME150G3I	15 kg	91 x 12 x 12 cm	
SD425ME200G3I	17.5 kg	101 x 12 x 12 cm	
SD425ME300G3I	21 kg	114 x 12 x 12 cm	
SD425ME500G3I	30 kg	149 x 26 x 33 cm	

CÓDIGO	Ø DESCARGA	POTENCIA	VOLTAJE	CORRIENTE	ETAPAS	FLUJO MÁXIMO	PRESIÓN MÁXIMA	PUNTO DE MAYOR EFICIENCIA
SD425ME100F3I	2"	1 HP	110 V ~ 60Hz 1Φ	15.5 A	7	158 l/min	50 m	95 l/min a 35 m
SD425ME100G3I	2"	1 HP	220 V ~ 60Hz 1Φ	7.6 A	7	158 l/min	50 m	95 l/min a 35 m
SD425ME150G3I	2"	1.5 HP	220 V ~ 60Hz 1Φ	9.4 A	8	158 l/min	81 m	95 l/min a 58 m
SD425ME200G3I	2"	2 HP	220 V ~ 60Hz 1Φ	12 A	11	158 l/min	101 m	95 l/min a 68 m
SD425ME300G3I	2"	3 HP	220 V ~ 60Hz 1Φ	15.6 A	15	158 l/min	151 m	95 l/min a 98 m
SD425ME500G3I	2"	5 HP	220 V ~ 60Hz 1Φ	25.9 A	24	158 l/min	252 m	95 l/min a 180 m



EQUIPO DE RIEGO SUMERGIBLE INOX. 4" | 25 GPM

CLASE 1H

Desempeño de altura

BOMBAS SUMERGIBLES



- La mejor eficiencia y desempeño en su categoría.
- Impulsores y difusores fabricados en acero inoxidable 304.
- Válvula check integrada.

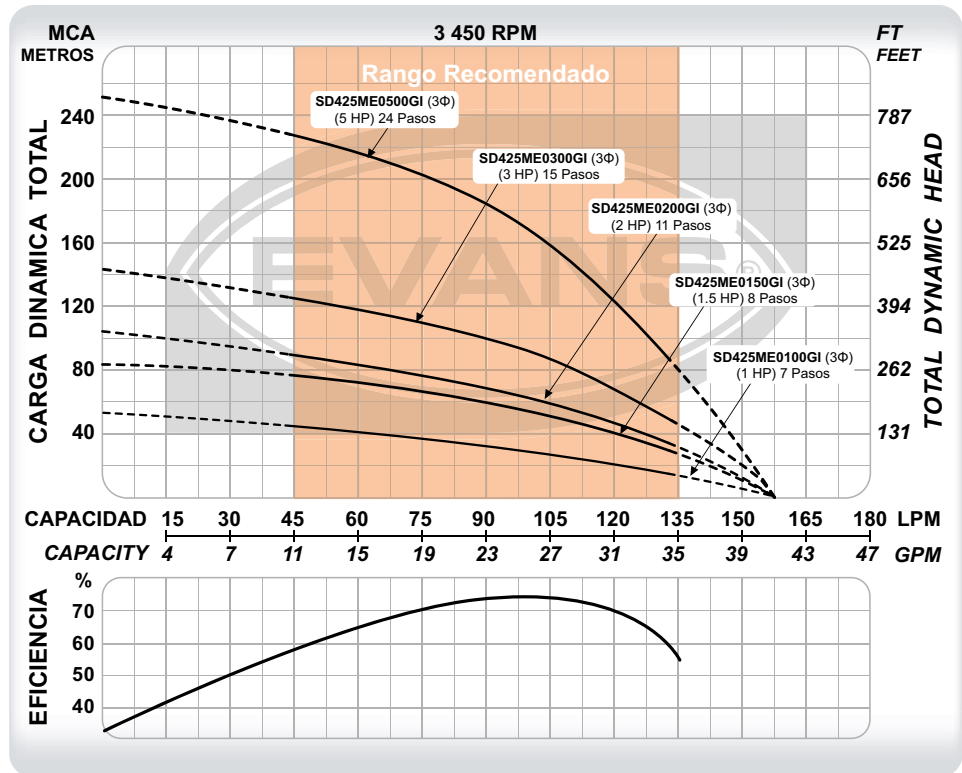

CÓDIGO	PESO	MEDIDAS
		LARGO X ANCHO X ALTO
SD425ME0100GI	13 kg	90 x 12 x 12 cm
SD425ME0150GI	14 kg	94 x 12 x 12 cm
SD425ME0200GI	16.5 kg	101 x 12 x 12 cm
SD425ME0300GI	20 kg	115 x 12 x 12 cm
SD425ME0500GI	31 kg	149 x 26 x 33 cm

CÓDIGO	Ø DESCARGA	POTENCIA	VOLTAJE	CORRIENTE	ETAPAS	FLUJO MÁXIMO	PRESIÓN MÁXIMA	PUNTO DE MAYOR EFICIENCIA
SD425ME0100GI	2"	1 HP	220 V ~ 60Hz 3Φ	5.5 A	7	158 l/min	50 m	95 l/min a 35 m
SD425ME0150GI	2"	1.5 HP	220 V ~ 60Hz 3Φ	6.4 A	8	158 l/min	81 m	95 l/min a 58 m
SD425ME0200GI	2"	2 HP	220 V ~ 60Hz 3Φ	8.2 A	11	158 l/min	101 m	95 l/min a 68 m
SD425ME0300GI	2"	3 HP	220 V ~ 60Hz 3Φ	10.9 A	15	158 l/min	151 m	95 l/min a 98 m
SD425ME0500GI	2"	5 HP	220 V ~ 60Hz 3Φ	17.3 A	24	158 l/min	252 m	95 l/min a 180 m

EQUIPO DE RIEGO SUMERGIBLE INOX. 4" | 25 GPM

Desempeño de altura

CLASE 1H



- La mejor eficiencia y desempeño en su categoría.
- Impulsores y difusores fabricados en acero inoxidable 304.
- Válvula check integrada.



BOMBAS SUMERGIBLES

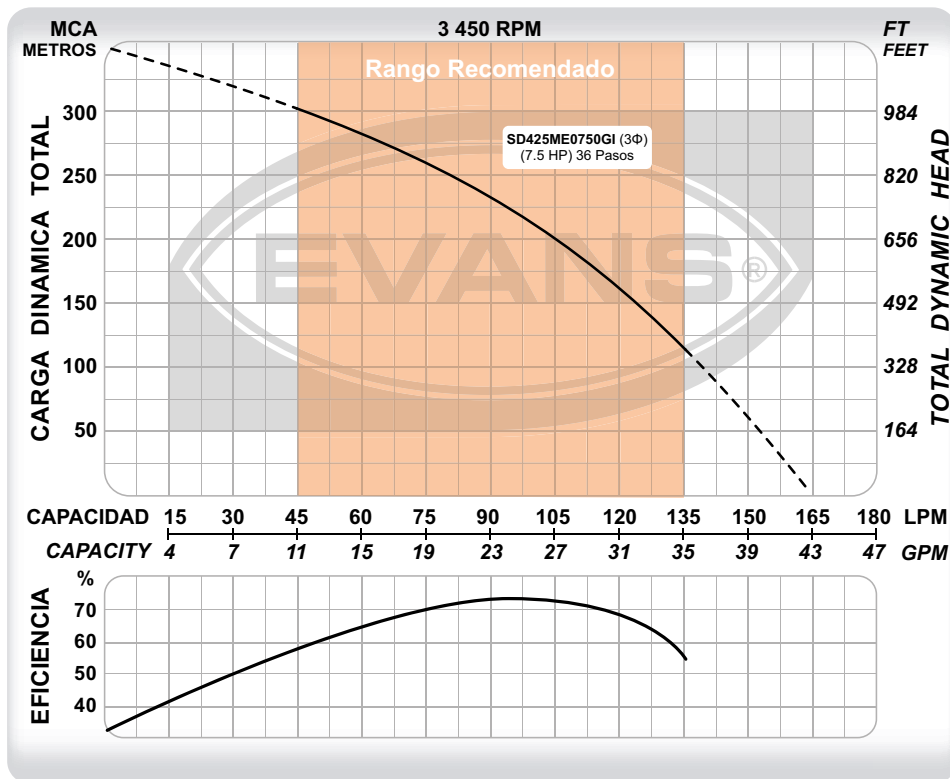

CÓDIGO	PESO	MEDIDAS
SD425ME0750GI	38 kg	LARGO X ANCHO X ALTO 184 x 26 x 33 cm

CÓDIGO	Ø DESCARGA	POTENCIA	VOLTAJE	CORRIENTE	ETAPAS	FLUJO MÁXIMO	PRESIÓN MÁXIMA	PUNTO DE MAYOR EFICIENCIA
SD425ME0750GI	2"	7.5 HP	220 V ~ 60Hz 3Φ	25.9 A	36	165 l/min	350 m	95 l/min a 225 m



CLASE IH

EQUIPO DE RIEGO SUMERGIBLE 4" | 25 GPM

Desempeño de altura

BOMBAS SUMERGIBLES



- La más resistente a la arena en su categoría.
- Impulsores tipo flotantes fabricados en Noryl®.
- Difusores fabricados en policarbonato.
- Descarga y cople en acero inoxidable extra resistentes.
- Válvula check integrada.

LOS EQUIPOS MONOFÁSICOS INCLUYEN CAJA DE CONTROL METÁLICA HERMÉTICAMENTE SELLADA.

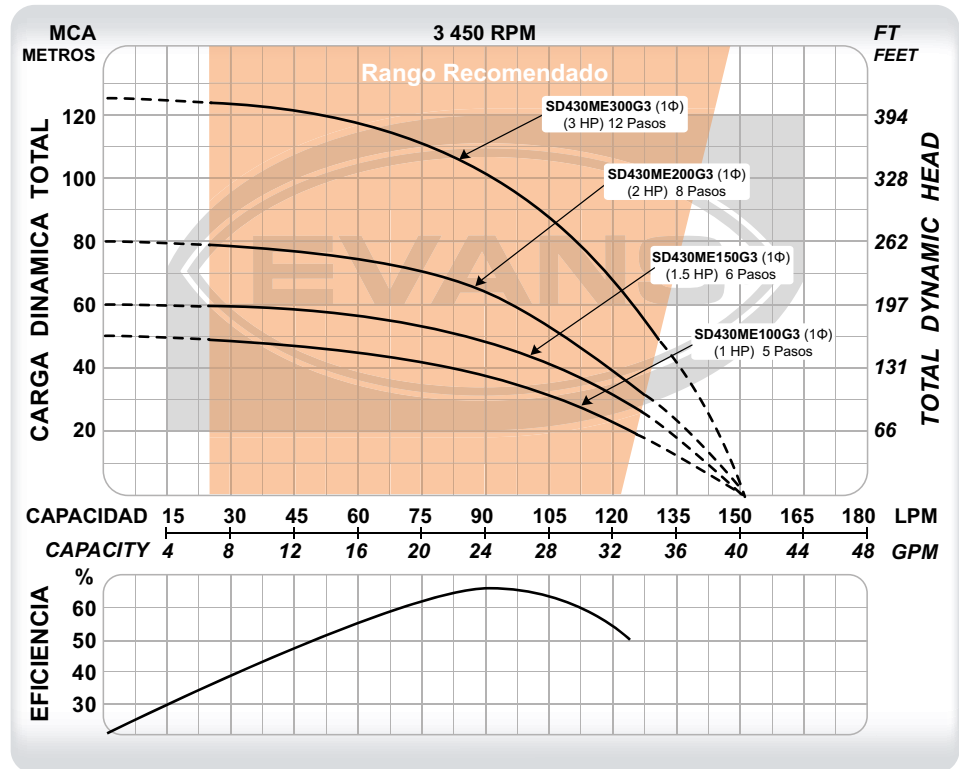

CÓDIGO	PESO	MEDIDAS LARGO X ANCHO X ALTO
SD430ME100G3	14 kg	85 x 12 x 12 cm
SD430ME150G3	16 kg	94 x 12 x 12 cm
SD430ME200G3	18 kg	105 x 12 x 12 cm
SD430ME300G3	22 kg	121 x 12 x 12 cm

CÓDIGO	Ø DESCARGA	POTENCIA	VOLTAJE	CORRIENTE	ETAPAS	FLUJO MÁXIMO	PRESIÓN MÁXIMA	PUNTO DE MAYOR EFICIENCIA
SD430ME100G3	2"	1 HP	220 V ~ 60Hz 1Φ	7.6 A	5	150 l/min	50 m	90 l/min a 38 m
SD430ME150G3	2"	1.5 HP	220 V ~ 60Hz 1Φ	9.4 A	6	150 l/min	60 m	90 l/min a 43 m
SD430ME200G3	2"	2 HP	220 V ~ 60Hz 1Φ	12 A	8	150 l/min	79 m	90 l/min a 62 m
SD430ME300G3	2"	3 HP	220 V ~ 60Hz 1Φ	15.6 A	12	150 l/min	123 m	90 l/min a 99 m

EQUIPO DE RIEGO SUMERGIBLE 4" | 25 GPM

Desempeño de altura

CLASE 1H



- La más resistente a la arena en su categoría.
- Impulsores tipo flotantes fabricados en Noryl®.
- Difusores fabricados en policarbonato.
- Descarga y cople en acero inoxidable extra resistentes.
- Válvula check integrada.



BOMBAS SUMERGIBLES

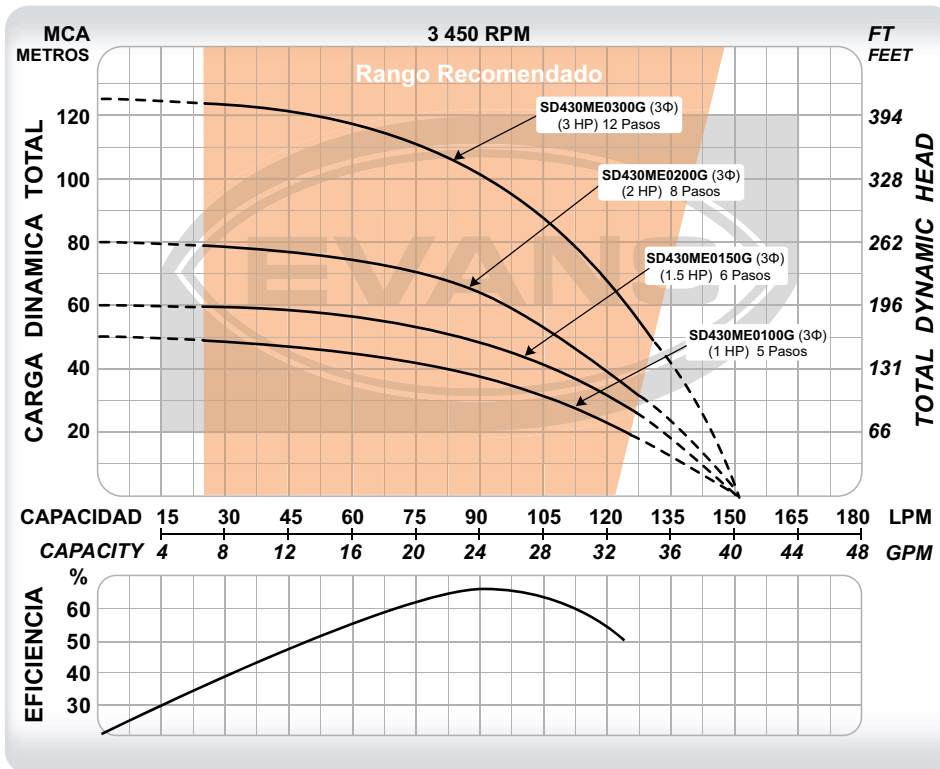

CÓDIGO	PESO	MEDIDAS
		LARGO X ANCHO X ALTO
SD430ME0100G	14 kg	90 x 12 x 12 cm
SD430ME0150G	15 kg	95 x 12 x 12 cm
SD430ME0200G	18 kg	105 x 12 x 12 cm
SD430ME0300G	20 kg	125 x 12 x 12 cm

CÓDIGO	Ø DESCARGA	POTENCIA	VOLTAJE	CORRIENTE	ETAPAS	FLUJO MÁXIMO	PRESIÓN MÁXIMA	PUNTO DE MAYOR EFICIENCIA
SD430ME0100G	2"	1 HP	220 V ~ 60Hz 3Φ	5.5 A	5	150 l/min	50 m	90 l/min a 38 m
SD430ME0150G	2"	1.5 HP	220 V ~ 60Hz 3Φ	6.4 A	6	150 l/min	60 m	90 l/min a 43 m
SD430ME0200G	2"	2 HP	220 V ~ 60Hz 3Φ	8.2 A	8	150 l/min	79 m	90 l/min a 62 m
SD430ME0300G	2"	3 HP	220 V ~ 60Hz 3Φ	10.9 A	12	150 l/min	123 m	90 l/min a 99 m



CLASE 1H

EQUIPO DE RIEGO SUMERGIBLE 4" | 25 GPM

Desempeño de altura

BOMBAS SUMERGIBLES



- La más resistente a la arena en su categoría.
- Impulsores tipo flotantes fabricados en Noryl®.
- Difusores fabricados en policarbonato.
- Descarga y cople en acero inoxidable extra resistentes.
- Válvula check integrada.



LOS EQUIPOS MONOFÁSICOS INCLUYEN CAJA DE CONTROL METÁLICA HERMÉTICAMENTE SELLADA.

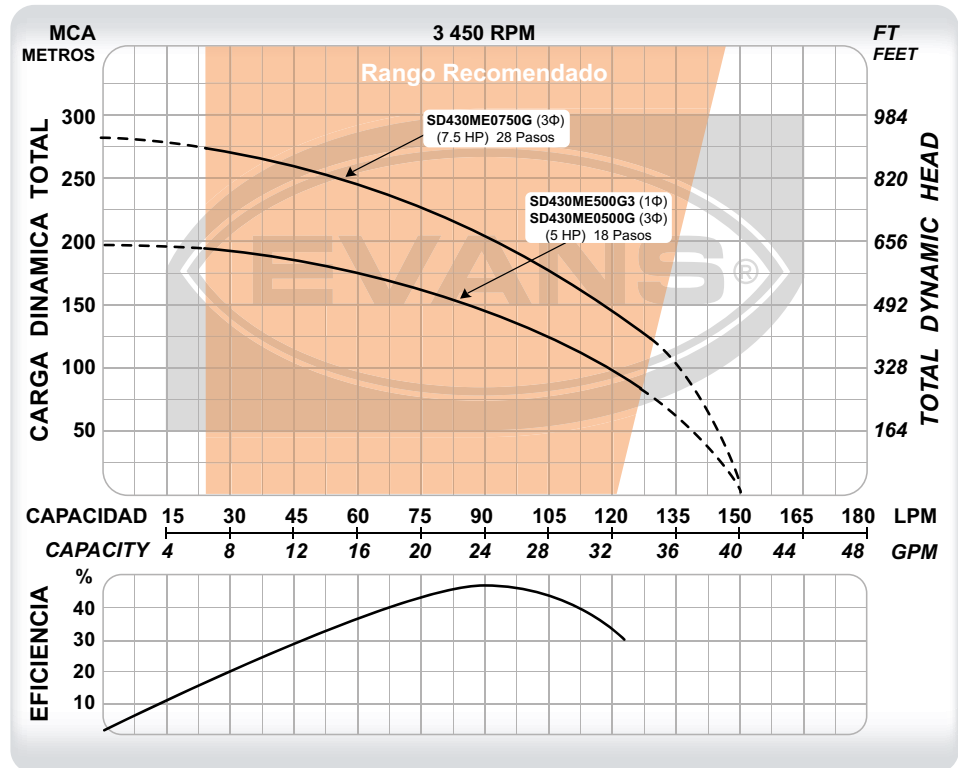

CÓDIGO	PESO	MEDIDAS
		LARGO X ANCHO X ALTO
SD430ME500G3	31 kg	160 x 26 x 33 cm
SD430ME0500G	30 kg	160 x 26 x 33 cm
SD430ME0750G	41 kg	200 x 26 x 33 cm

CÓDIGO	Ø DESCARGA	POTENCIA	VOLTAJE	CORRIENTE	ETAPAS	FLUJO MÁXIMO	PRESIÓN MÁXIMA	PUNTO DE MAYOR EFICIENCIA
SD430ME500G3	2"	5 HP	220 V ~ 60Hz 1Φ	25.9 A	18	150 l/min	187 m	90 l/min a 145 m
SD430ME0500G	2"	5 HP	220 V ~ 60Hz 3Φ	17.3 A	18	150 l/min	187 m	90 l/min a 145 m
SD430ME0750G	2"	7.5 HP	220 V ~ 60Hz 3Φ	25.9 A	28	150 l/min	282 m	90 l/min a 205 m

EQUIPO DE RIEGO SUMERGIBLE 4" | 40 GPM

Desempeño de Altura

CLASE 1H



- La más resistente a la arena en su categoría.
- Impulsores tipo flotantes fabricados en Noryl®.
- Difusores fabricados en policarbonato.
- Descarga y cople en acero inoxidable extra resistentes.
- Válvula check integrada.



BOMBAS SUMERGIBLES



LOS EQUIPOS MONOFÁSICOS INCLUYEN CAJA DE CONTROL METÁLICA HERMÉTICAMENTE SELLADA.

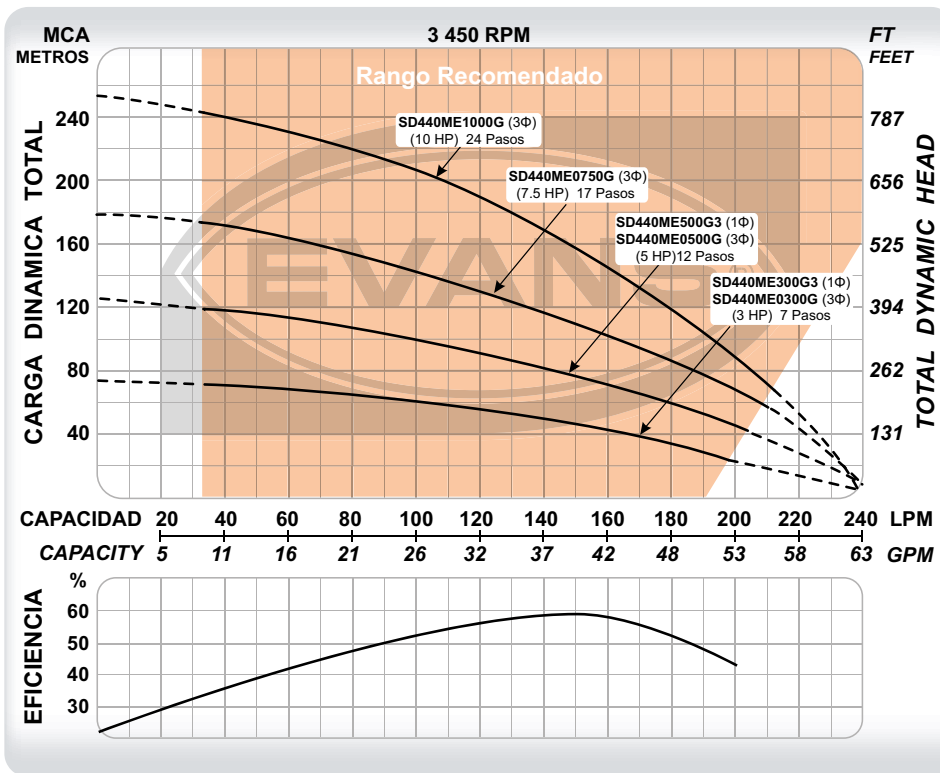

CÓDIGO	PESO	MEDIDAS LARGO X ANCHO X ALTO
SD440ME300G3	21 kg	115 x 12 x 12 cm
SD440ME500G3	30 kg	155 x 26 x 33 cm
SD440ME0300G	20 kg	115 x 12 x 12 cm
SD440ME0500G	29 kg	155 x 26 x 33 cm
SD440ME0750G	37 kg	195 x 26 x 33 cm
SD440ME1000G	46 kg	245 x 26 x 33 cm

CÓDIGO	Ø DESCARGA	POTENCIA	VOLTAJE	CORRIENTE	ETAPAS	FLUJO MÁXIMO	PRESIÓN MÁXIMA	PUNTO DE MAYOR EFICIENCIA
SD440ME300G3	2"	3 HP	220 V ~ 60Hz 1Φ	15.6 A	7	245 l/min	72 m	150 l/min a 45 m
SD440ME500G3	2"	5 HP	220 V ~ 60Hz 1Φ	25.9 A	12	245 l/min	125 m	150 l/min a 75 m
SD440ME0300G	2"	3 HP	220 V ~ 60Hz 3Φ	10.9 A	7	245 l/min	72 m	150 l/min a 45 m
SD440ME0500G	2"	5 HP	220 V ~ 60Hz 3Φ	17.3 A	12	245 l/min	125 m	150 l/min a 75 m
SD440ME0750G	2"	7.5 HP	220 V ~ 60Hz 3Φ	25.9 A	17	245 l/min	178 m	150 l/min a 110 m
SD440ME1000G	2"	5 HP	220 V ~ 60Hz 3Φ	36.2 A	24	245 l/min	248 m	150 l/min a 160 m

DEBIDO A LAS MEJORAS CONSTANTES, EL PRODUCTO PUEDE VARIAR EN SU APARIENCIA. ESPECIFICACIONES SUJETAS A CAMBIO SIN PREVIO AVISO.



EQUIPO DE RIEGO SUMERGIBLE INOX. 4" I 45 GPM

CLASE 1H

Desempeño de altura

BOMBAS SUMERGIBLES



- La mejor eficiencia y desempeño en su categoría.
- Impulsores y difusores fabricados en acero inoxidable 304.
- Válvula check integrada.

LOS EQUIPOS MONOFÁSICOS INCLUYEN CAJA DE CONTROL METÁLICA HERMÉTICAMENTE SELLADA.

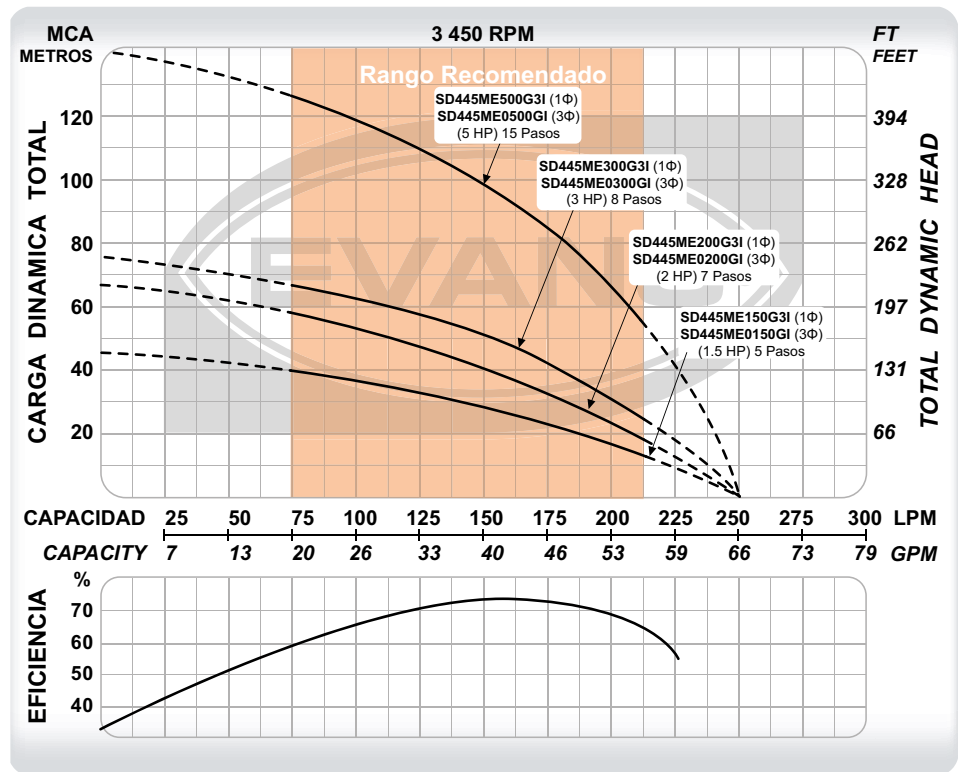

CÓDIGO	PESO	MEDIDAS LARGO X ANCHO X ALTO
SD445ME150G3I	14.5 kg	88 x 12 x 12 cm
SD445ME200G3I	17 kg	98 x 12 x 12 cm
SD445ME300G3I	19.5 kg	105 x 12 x 12 cm
SD445ME500G3I	29 kg	138 x 26 x 33 cm
SD445ME0150GI	14.5 kg	91 x 12 x 12 cm
SD445ME0200GI	16 kg	97 x 12 x 12 cm
SD445ME0300GI	19 kg	106 x 12 x 12 cm
SD445ME0500GI	30 kg	138 x 26 x 33 cm

CÓDIGO	Ø DESCARGA	POTENCIA	VOLTAJE	CORRIENTE	ETAPAS	FLUJO MÁXIMO	PRESIÓN MÁXIMA	PUNTO DE MAYOR EFICIENCIA
SD445ME150G3I	2"	1.5 HP	220 V ~ 60Hz 1Φ	9.4 A	5	250 l/min	48 m	155 l/min a 28 m
SD445ME200G3I	2"	2 HP	220 V ~ 60Hz 1Φ	12 A	7	250 l/min	67 m	155 l/min a 40 m
SD445ME300G3I	2"	3 HP	220 V ~ 60Hz 1Φ	15.6 A	8	250 l/min	75 m	155 l/min a 50 m
SD445ME500G3I	2"	5 HP	220 V ~ 60Hz 1Φ	25.9 A	15	250 l/min	140 m	155 l/min a 98 m
SD445ME0150GI	2"	1.5 HP	220 V ~ 60Hz 3Φ	6.4 A	5	250 l/min	48 m	155 l/min a 28 m
SD445ME0200GI	2"	2 HP	220 V ~ 60Hz 3Φ	8.2 A	7	250 l/min	67 m	155 l/min a 40 m
SD445ME0300GI	2"	3 HP	220 V ~ 60Hz 3Φ	10.9 A	8	250 l/min	75 m	155 l/min a 50 m
SD445ME0500GI	2"	5 HP	220 V ~ 60Hz 3Φ	17.3 A	15	250 l/min	140 m	155 l/min a 98 m

EQUIPO DE RIEGO SUMERGIBLE INOX. 4" | 45 GPM

Desempeño de altura

CLASE 1H



- La mejor eficiencia y desempeño en su categoría.
- Impulsores y difusores fabricados en acero inoxidable 304.
- Válvula check integrada.



BOMBAS SUMERGIBLES

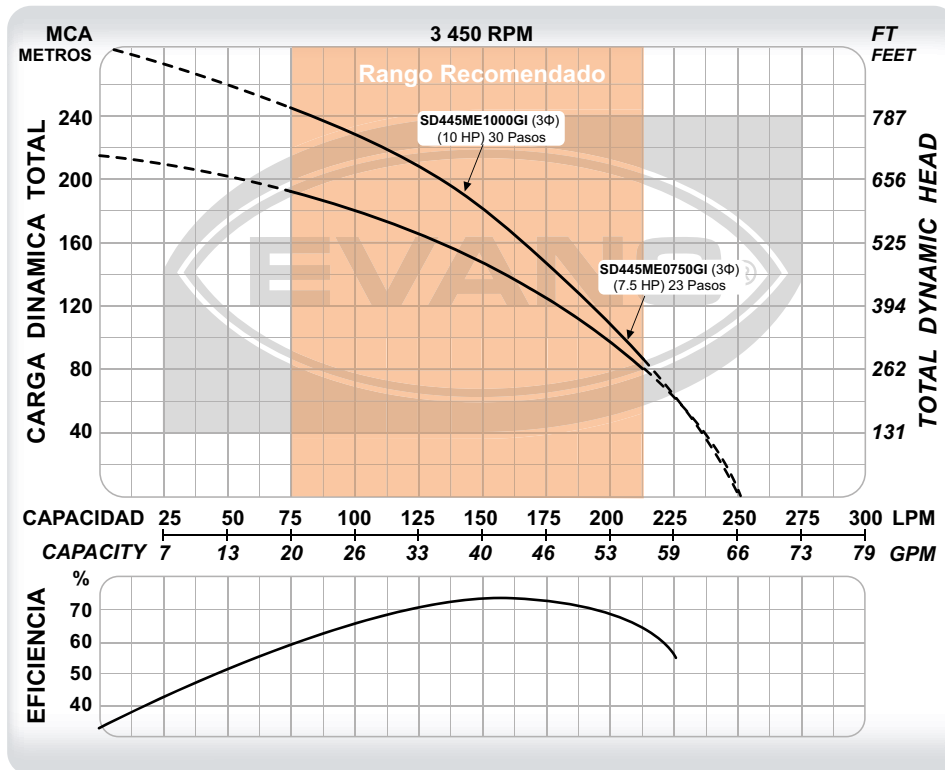

CÓDIGO	PESO	MEDIDAS LARGO X ANCHO X ALTO
SD445ME0750GI	36 kg	169 x 26 x 33 cm
SD445ME1000GI	45 kg	205 x 26 x 33 cm

CÓDIGO	Ø DESCARGA	POTENCIA	VOLTAJE	CORRIENTE	ETAPAS	FLUJO MÁXIMO	PRESIÓN MÁXIMA	PUNTO DE MAYOR EFICIENCIA
SD445ME0750GI	2"	7.5 HP	220 V ~ 60Hz 3Φ	25.9 A	23	250 l/min	219 m	155 l/min a 147 m
SD445ME1000GI	2"	10 HP	220 V ~ 60Hz 3Φ	36.2 A	30	250 l/min	290 m	155 l/min a 180 m



EQUIPO DE RIEGO SUMERGIBLE INOX. 4" I 60 GPM

CLASE 1H

Desempeño de altura

BOMBAS SUMERGIBLES



- La mejor eficiencia y desempeño en su categoría.
- Impulsores y difusores fabricados en acero inoxidable 304.
- Válvula check integrada.

LOS EQUIPOS MONOFÁSICOS INCLUYEN CAJA DE CONTROL METÁLICA HERMÉTICAMENTE SELLADA.

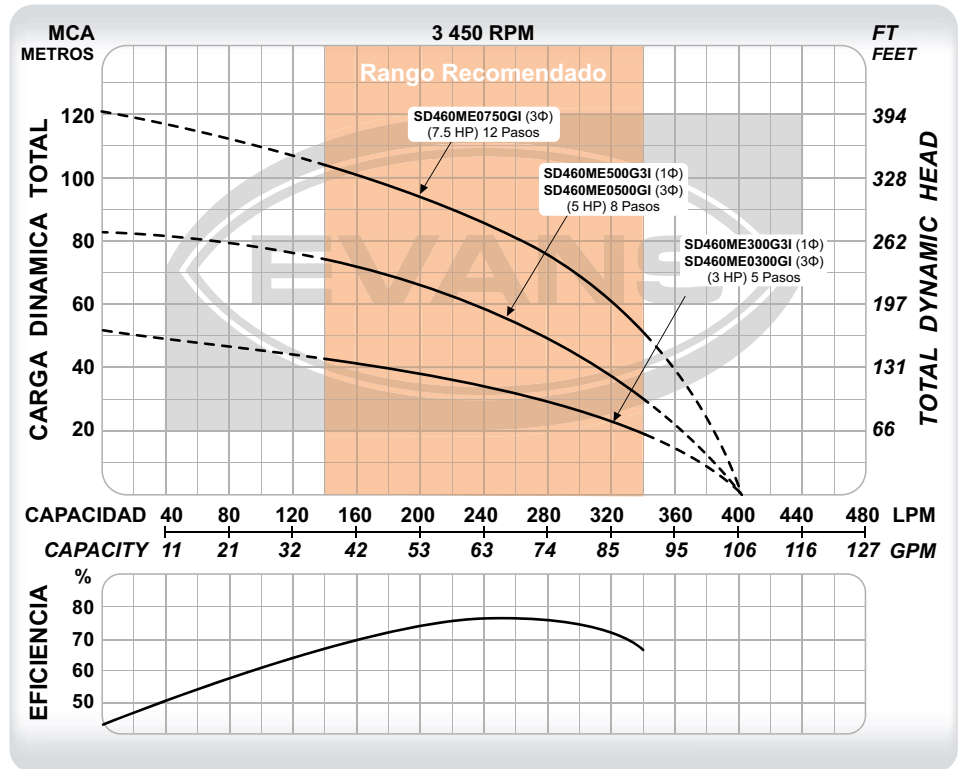

CÓDIGO	PESO	MEDIDAS LARGO X ANCHO X ALTO
SD460ME300G3I	20 kg	108 x 12 x 12 cm
SD460ME500G3I	29 kg	137 x 26 x 33 cm
SD460ME0300GI	19.5 kg	109 x 12 x 12 cm
SD460ME0500GI	30 kg	137 x 26 x 33 cm
SD460ME0750GI	37 kg	169 x 26 x 33 cm

CÓDIGO	Ø DESCARGA	POTENCIA	VOLTAJE	CORRIENTE	ETAPAS	FLUJO MÁXIMO	PRESIÓN MÁXIMA	PUNTO DE MAYOR EFICIENCIA
SD460ME300G3I	2"	3 HP	220 V ~ 60Hz 1Φ	15.6 A	5	400 l/min	51 m	240 l/min a 34 m
SD460ME500G3I	2"	5 HP	220 V ~ 60Hz 1Φ	25.9 A	8	400 l/min	82 m	240 l/min a 59 m
SD460ME0300GI	2"	3 HP	220 V ~ 60Hz 3Φ	10.9 A	5	400 l/min	51 m	240 l/min a 34 m
SD460ME0500GI	2"	5 HP	220 V ~ 60Hz 3Φ	17.3 A	8	400 l/min	82 m	240 l/min a 59 m
SD460ME0750GI	2"	7.5 HP	220 V ~ 60Hz 3Φ	25.9 A	12	400 l/min	120 m	240 l/min a 85 m

EQUIPO DE RIEGO SUMERGIBLE INOX. 4" I 60 GPM

Desempeño de altura

CLASE 1H



- La mejor eficiencia y desempeño en su categoría.
- Impulsores y difusores fabricados en acero inoxidable 304.
- Válvula check integrada.



BOMBAS SUMERGIBLES

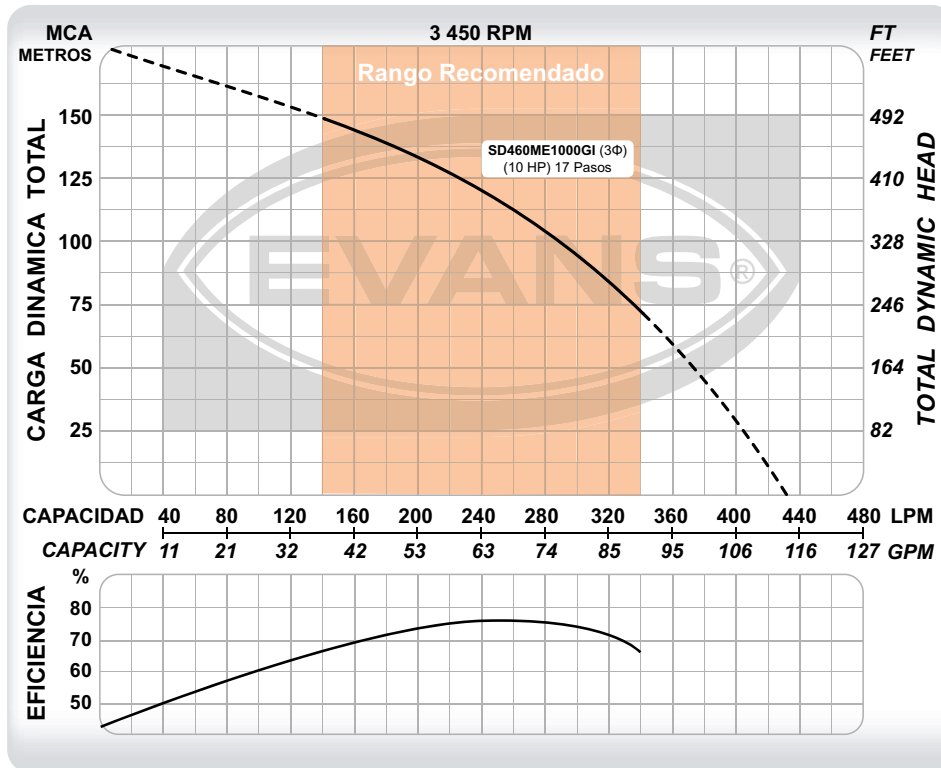

CÓDIGO	PESO	MEDIDAS
SD460ME1000GI	46.5 kg	LARGO X ANCHO X ALTO 207 x 26 x 33 cm

CÓDIGO	Ø DESCARGA	POTENCIA	VOLTAJE	CORRIENTE	ETAPAS	FLUJO MÁXIMO	PRESIÓN MÁXIMA	PUNTO DE MAYOR EFICIENCIA
SD460ME1000GI	2"	10 HP	220 V ~ 60Hz 3Φ	36.2 A	17	430 l/min	175 m	240 l/min a 117 m



CLASE 1H

EQUIPO DE RIEGO SUMERGIBLE 4" | 70 GPM

Desempeño de altura

BOMBAS SUMERGIBLES



- La más resistente a la arena en su categoría.
- Impulsores tipo flotantes fabricados en Noryl®.
- Difusores fabricados en policarbonato.
- Descarga y cople en acero inoxidable extra resistentes.
- Válvula check integrada.

LOS EQUIPOS MONOFÁSICOS INCLUYEN CAJA DE CONTROL METÁLICA HERMÉTICAMENTE SELLADA.

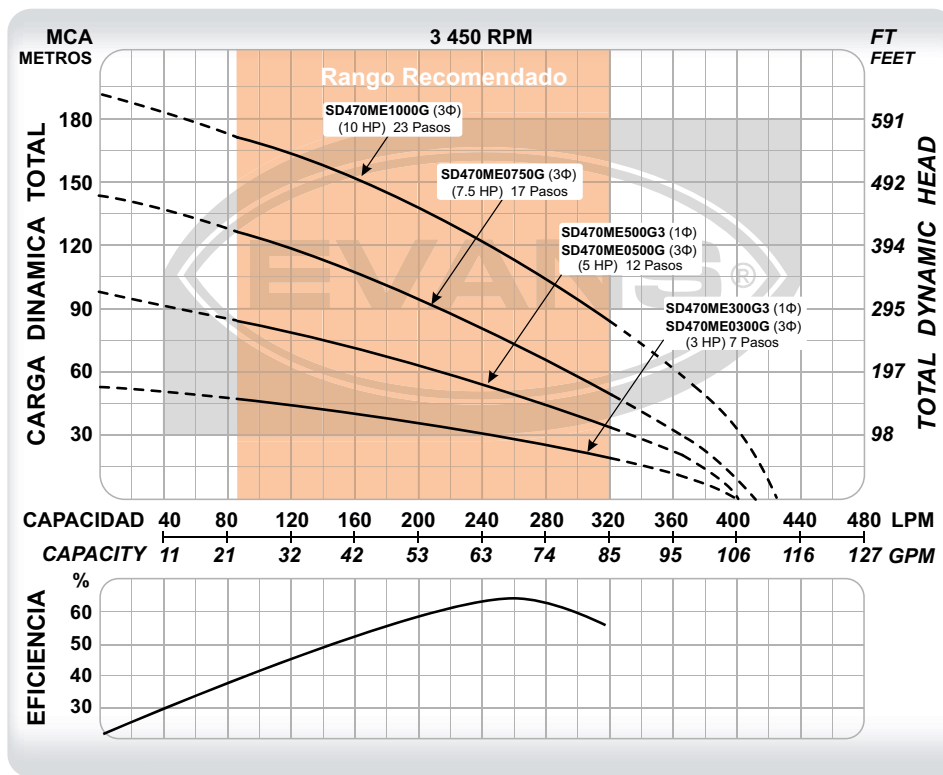

CÓDIGO	PESO	MEDIDAS
		LARGO X ANCHO X ALTO
SD470ME300G3	22 kg	130 x 12 x 12 cm
SD470ME500G3	32 kg	175 x 26 x 33 cm
SD470ME0300G	21 kg	130 x 12 x 12 cm
SD470ME0500G	31 kg	175 x 26 x 33 cm
SD470ME0750G	40 kg	230 x 26 x 33 cm
SD470ME1000G	50 kg	287 x 26 x 33 cm

CÓDIGO	Ø DESCARGA	POTENCIA	VOLTAJE	CORRIENTE	ETAPAS	FLUJO MÁXIMO	PRESIÓN MÁXIMA	PUNTO DE MAYOR EFICIENCIA
SD470ME300G3	2"	3 HP	220 V ~ 60Hz 1Φ	15.6 A	7	395 l/min	56 m	260 l/min a 28 m
SD470ME500G3	2"	5 HP	220 V ~ 60Hz 1Φ	25.9 A	12	395 l/min	96 m	260 l/min a 50 m
SD470ME0300G	2"	3 HP	220 V ~ 60Hz 3Φ	10.9 A	7	395 l/min	56 m	260 l/min a 28 m
SD470ME0500G	2"	5 HP	220 V ~ 60Hz 3Φ	17.3 A	12	395 l/min	96 m	260 l/min a 50 m
SD470ME0750G	2"	7.5 HP	220 V ~ 60Hz 3Φ	25.9 A	17	410 l/min	145 m	260 l/min a 73 m
SD470ME1000G	2"	10 HP	220 V ~ 60Hz 3Φ	36.2 A	23	420 l/min	191 m	260 l/min a 113 m

EQUIPO DE RIEGO SUMERGIBLE 4" | 100 GPM

Desempeño de altura

CLASE 1H



- La más resistente a la arena en su categoría.
- Impulsores tipo flotantes fabricados en Noryl®.
- Difusores fabricados en policarbonato.
- Descarga y cople en acero inoxidable extra resistentes.
- Válvula check integrada.



BOMBAS SUMERGIBLES



LOS EQUIPOS MONOFÁSICOS INCLUYEN CAJA DE CONTROL METÁLICA HERMÉTICAMENTE SELLADA.

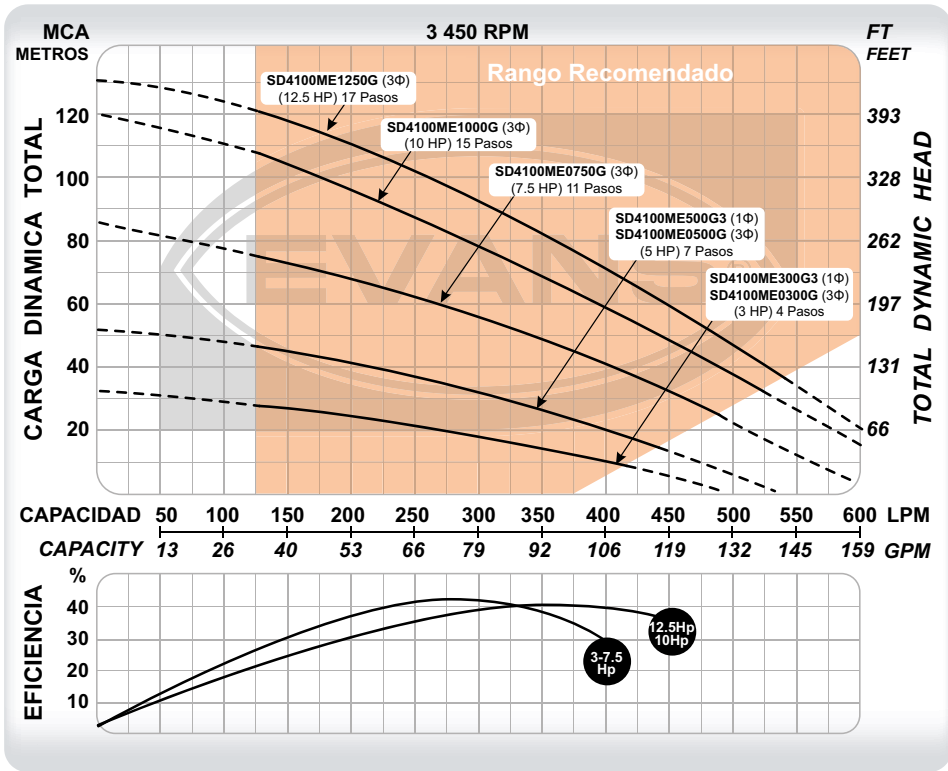

CÓDIGO	PESO	MEDIDAS	
		LARGO X ANCHO X ALTO	
SD4100ME300G3	19 kg	115 x 12 x 12 cm	
SD4100ME500G3	27 kg	140 x 26 x 33 cm	
SD4100ME0300G	18 kg	130 x 12 x 12 cm	
SD4100ME0500G	26 kg	140 x 26 x 33 cm	
SD4100ME0750G	36 kg	180 x 26 x 33 cm	
SD4100ME1000G	44 kg	220 x 26 x 33 cm	
SD4100ME1250G	50 kg	250 x 26 x 33 cm	

CÓDIGO	Ø DESCARGA	POTENCIA	VOLTAJE	CORRIENTE	ETAPAS	FLUJO MÁXIMO	PRESIÓN MÁXIMA	PUNTO DE MAYOR EFICIENCIA
SD4100ME300G3	2"	3 HP	220 V ~ 60Hz 1Φ	15.9 A	4	485 l/min	31 m	270 l/min a 20 m
SD4100ME500G3	2"	5 HP	220 V ~ 60Hz 1Φ	25.9 A	7	530 l/min	55 m	270 l/min a 35 m
SD4100ME0300G	2"	3 HP	220 V ~ 60Hz 3Φ	10.9 A	4	485 l/min	31 m	270 l/min a 20 m
SD4100ME0500G	2"	5 HP	220 V ~ 60Hz 3Φ	17.3 A	7	530 l/min	55 m	270 l/min a 35 m
SD4100ME0750G	2"	7.5 HP	220 V ~ 60Hz 3Φ	29.9 A	11	600 l/min	85 m	270 l/min a 59 m
SD4100ME1000G	2"	10 HP	220 V ~ 60Hz 3Φ	36.2 A	15	630 l/min	119 m	370 l/min a 64 m
SD4100ME1250G	2"	12.5 HP	220 V ~ 60Hz 3Φ	44.9 A	17	630 l/min	135 m	370 l/min a 75 m

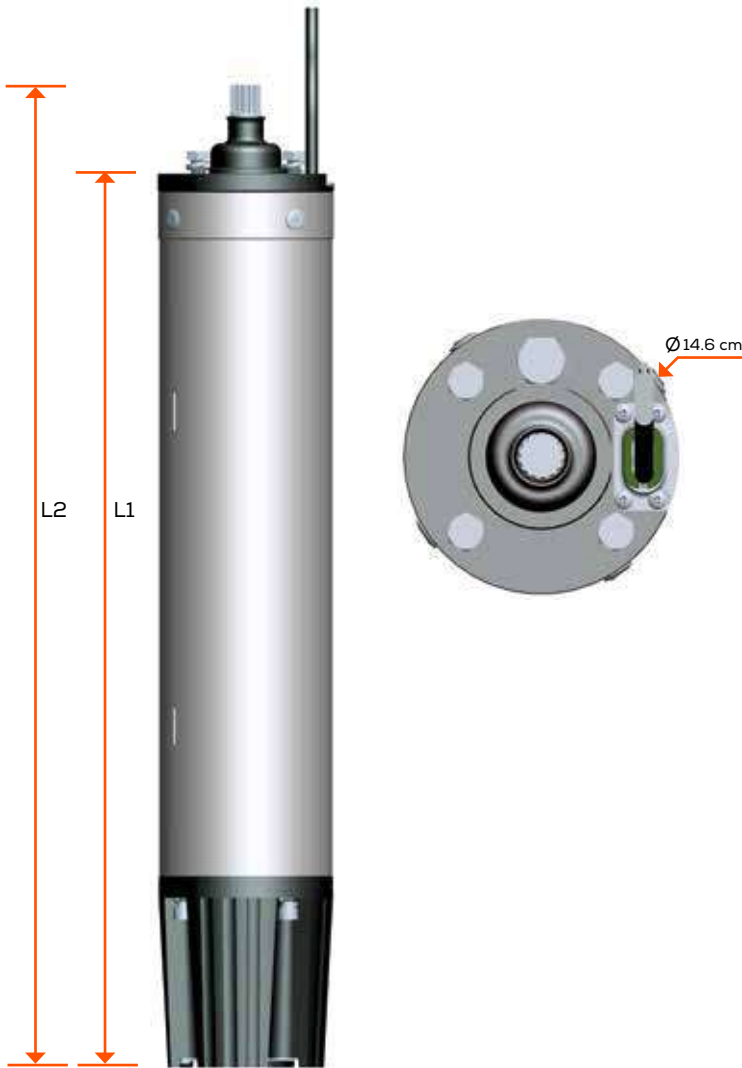

- Los motores sumergibles EVANS® de 6" tienen un mecanismo de enfriamiento a base de aceite de origen vegetal.
- Son compatible con las unidades de bombeo de diferentes marcas que tengan cumplimiento NEMA.
- Acoplamiento NEMA 6.
- Motor con embobinado de cobre y aislamiento CLASE F, cumpliendo con los estándares de NEMA MW37-C.
- Rodamientos suecos tipo bola de contacto angular especialmente diseñados para el trabajo continuo y soportar mayores cargas axiales.
- Altamente eficientes con la vida útil más larga del mercado. Soporta hasta 20 arranques por hora.

CÓDIGO	POTENCIA (HP)	L1 (cm)	L2 (cm)	PESO (kg)	VOLTAJE	CORRIENTE NOMINAL (A)	FACTOR SERVICIO	CORRIENTE MÁX. (A)	EMPUJE AXIAL (N)
E26S1000G-P	10	62	69.3	34.4	220V ~ 60Hz 3Φ	30.4	1.15	35	6 500
E26S1000H-P					440V ~ 60Hz 3Φ	15.2		17.5	
E26S1500G-P	15	68.5	75.8	41.4	220V ~ 60Hz 3Φ	43.2		49.7	
E26S1500H-P					440V ~ 60Hz 3Φ	21.6		24.8	
E26S2000G-P	20	75.5	82.8	58.3	220V ~ 60Hz 3Φ	56.4		64.9	
E26S2000H-P					440V ~ 60Hz 3Φ	28.2		32.4	
E26S2500G-P	25	82	89.3	61	220V ~ 60Hz 3Φ	69		79.4	14 400
E26S2500H-P					440V ~ 60Hz 3Φ	34.5		39.7	
E26S3000G-P	30	88	95.3	69	220V ~ 60Hz 3Φ	81.6		93.8	
E26S3000H-P					440V ~ 60Hz 3Φ	40.8		46.9	
E26S3500H-P	35	93	100.3	77	440V ~ 60Hz 3Φ	51		58.7	
E26S4000H-P	40	98	105.3	84	440V ~ 60Hz 3Φ	56.7		65.2	
E26S5000H-P	50	111.8	119.1	92	440V ~ 60Hz 3Φ	75	86.3		
E26S6000H-P	60	124.1	131.4	95	440V ~ 60Hz 3Φ	90	103.5		

COMPONENTES	
No.	PARTES
1	Soporte motor
2	O-ring inferior
3	Soporte inferior
4	Carcasa del motor
5	Estator
6	Rotor
7	Soporte superior
8	Glándula del cable
9	Cable
10	Cubierta anti arena
11	Sello superior
12	Sello mecánico
13	O-ring superior
14	Rodamiento superior
15	Rodamiento inferior
16	Diafragma de compensación de presión
17	Protección contra impacto inferior
18	Anillo de sujeción

MATERIALES DE MOTOR	
Material del cuerpo	AISI 304
Rotor / Flecha	AISI 43L. Una sola pieza
Sello mecánico	Grafito /cerámica / NBR / AISI 304
Rodamientos de empuje	Acero 2Cr13, AISI304 y Carburo de silicio
Campana	AISI 304
Tornillería	AISI 304
Submersibilidad	300 m
Acoplamiento	NEMA
Aislamiento	Clase F
Temperatura máx.	35 °C
Rango de pH líquido	5.5 - 8.9

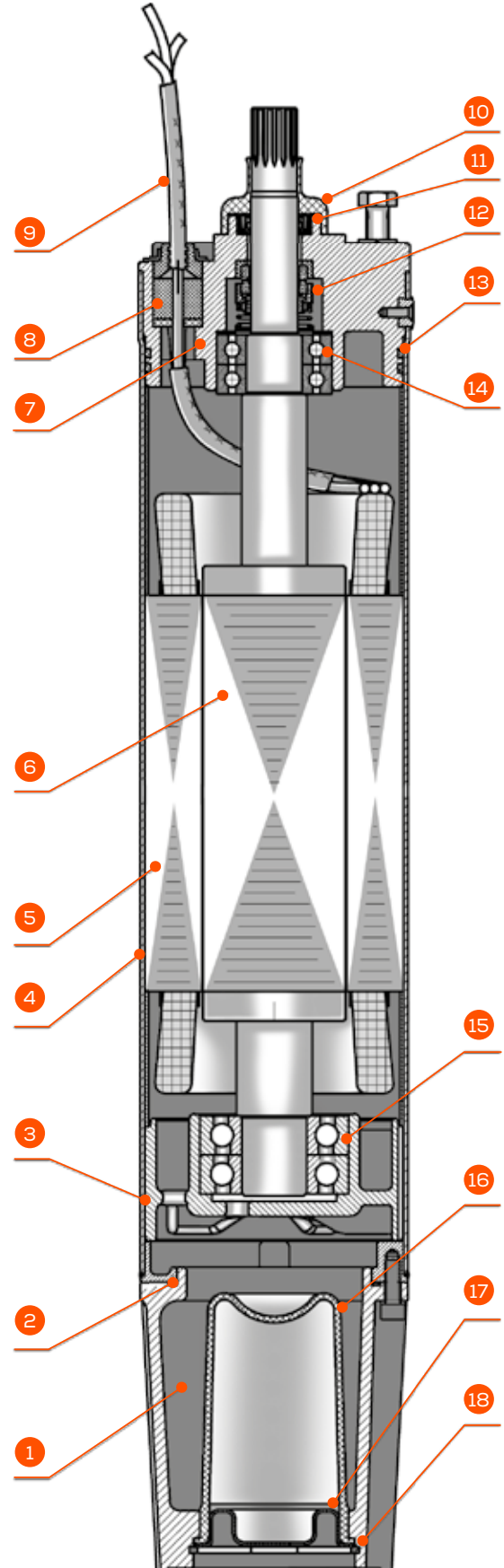

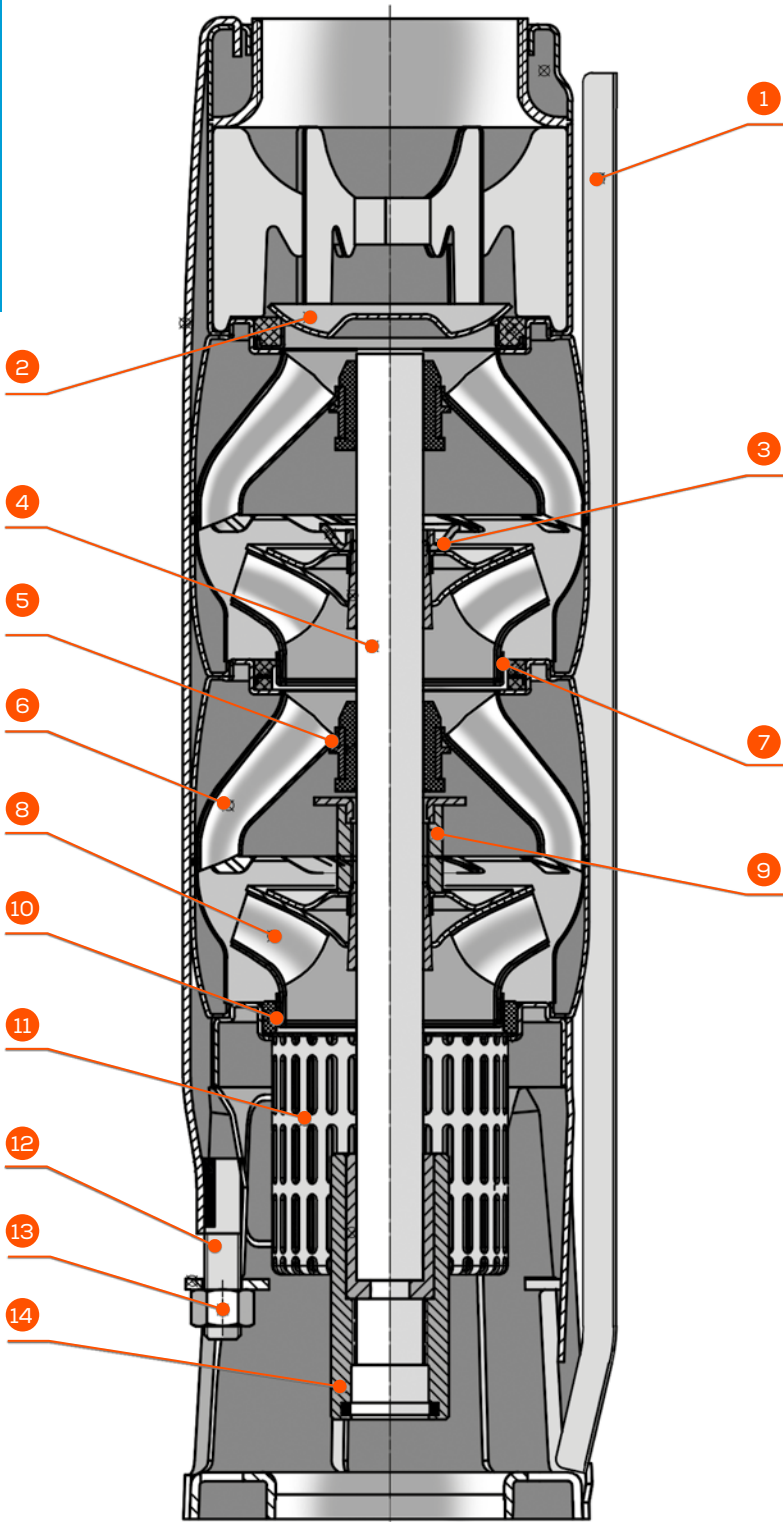

COMPONENTES

No.	PARTES
1	Guardacable
2	Válvula check
3	Tuerca del separador
4	Flecha
5	Rodamiento
6	Difusor
7	Anillo de sellado
8	Impulsor
9	Separador de etapas
10	Anillo de sujeción
11	Rejilla de succión
12	Tornillo
13	Tuerca
14	Cople

MATERIALES DE UNIDAD DE BOMBEO

Material del cuerpo	AISI 304
Descarga	AISI 304
Succión	AISI 304
Flecha de bomba	AISI 431
Cople	AISI 304
Protector de cable	AISI 304
Soporte de válvula check	AISI 304
Impulsores	AISI 304
Difusores	AISI 304
Válvula check	AISI 304
Rodamientos de bomba	Buna-N
Acoplamiento	NEMA
Máx. contenido de arena	5% ~ 50g/m ³
Rango de pH líquido	5.5 - 8.9

EQUIPO DE RIEGO SUMERGIBLE INOX. 6" I 80 GPM

Desempeño de altura

CLASE 10



- Bombas sumergibles para pozos profundos.
- La más eficiente en su categoría: mayor presión y flujo con menor consumo energético.
- Fabricación 100% en acero inoxidable 304.
- Válvula check integrada.



BOMBAS SUMERGIBLES

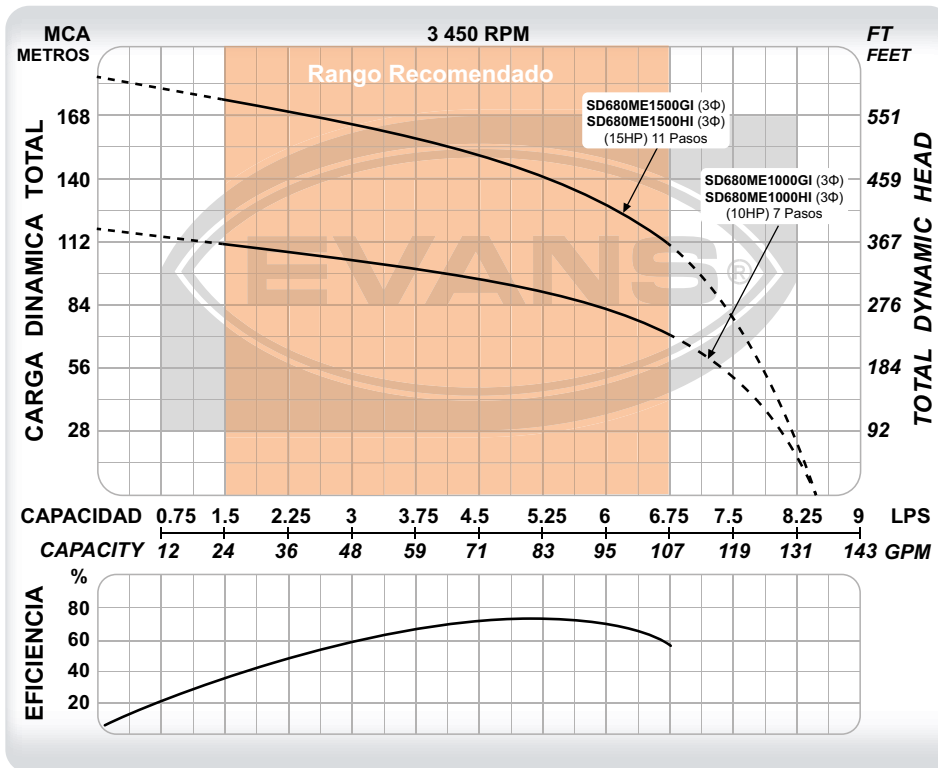

CÓDIGO	PESO	MEDIDAS LARGO X ANCHO X ALTO
SD680ME1000GI	51 kg	143 x 31 x 43 cm
SD680ME1500GI	63 kg	168 x 31 x 43 cm
SD680ME1000HI	51 kg	143 x 31 x 43 cm
SD680ME1500HI	63 kg	168 x 31 x 43 cm

CÓDIGO	Ø DESCARGA	POTENCIA	VOLTAJE	CORRIENTE	ETAPAS	FLUJO MÁXIMO	PRESIÓN MÁXIMA	PUNTO DE MAYOR EFICIENCIA
SD680ME1000GI	3"	10 HP	220 V ~ 60Hz 3Φ	35 A	7	8.5 l/s	118 m	5 l/s a 90 m
SD680ME1500GI	3"	15 HP	220 V ~ 60Hz 3Φ	49.7 A	11	8.5 l/s	185 m	5 l/s a 140 m
SD680ME1000HI	3"	10 HP	440 V ~ 60Hz 3Φ	17.5 A	7	8.5 l/s	118 m	5 l/s a 90 m
SD680ME1500HI	3"	15 HP	440 V ~ 60Hz 3Φ	24.8 A	11	8.5 l/s	185 m	5 l/s a 140 m



CLASE 10

EQUIPO DE RIEGO SUMERGIBLE INOX. 6" I 80 GPM

Desempeño de altura

BOMBAS SUMERGIBLES



- Bombas sumergibles para pozos profundos.
- La más eficiente en su categoría: mayor presión y flujo con menor consumo energético.
- Fabricación 100% en acero inoxidable 304.
- Válvula check integrada.

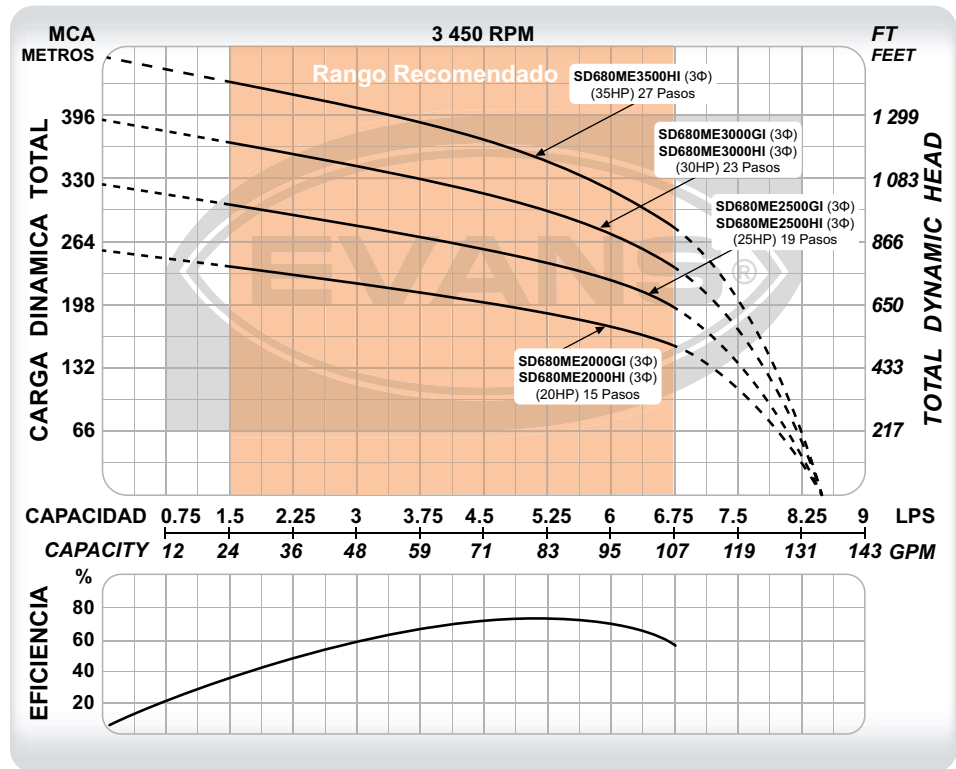

CÓDIGO	PESO	MEDIDAS
		LARGO X ANCHO X ALTO
SD680ME2000GI	82 kg	193 x 31 x 43 cm
SD680ME2500GI	88 kg	217 x 31 x 43 cm
SD680ME3000GI	102 kg	241 x 31 x 43 cm
SD680ME2000HI	82 kg	193 x 31 x 43 cm
SD680ME2500HI	88 kg	217 x 31 x 43 cm
SD680ME3000HI	102 kg	241 x 31 x 43 cm
SD680ME3500HI	111 kg	264 x 31 x 43 cm

CÓDIGO	Ø DESCARGA	POTENCIA	VOLTAJE	CORRIENTE	ETAPAS	FLUJO MÁXIMO	PRESIÓN MÁXIMA	PUNTO DE MAYOR EFICIENCIA
SD680ME2000GI	3"	20 HP	220 V ~ 60Hz 3Φ	64.9 A	15	8.5 l/s	252 m	5 l/s a 195 m
SD680ME2500GI	3"	25 HP	220 V ~ 60Hz 3Φ	79.4 A	19	8.5 l/s	320 m	5 l/s a 247 m
SD680ME3000GI	3"	30 HP	220 V ~ 60Hz 3Φ	93.8 A	23	8.5 l/s	387 m	5 l/s a 297 m
SD680ME2000HI	3"	20 HP	440 V ~ 60Hz 3Φ	32.4 A	15	8.5 l/s	252 m	5 l/s a 195 m
SD680ME2500HI	3"	25 HP	440 V ~ 60Hz 3Φ	39.7 A	19	8.5 l/s	320 m	5 l/s a 247 m
SD680ME3000HI	3"	30 HP	440 V ~ 60Hz 3Φ	46.9 A	23	8.5 l/s	387 m	5 l/s a 297 m
SD680ME3500HI	3"	35 HP	440 V ~ 60Hz 3Φ	58.7 A	27	8.5 l/s	454 m	5 l/s a 350 m

EQUIPO DE RIEGO SUMERGIBLE INOX. 6" I 80 GPM

Desempeño de altura

CLASE 10



- Bombas sumergibles para pozos profundos.
- La más eficiente en su categoría: mayor presión y flujo con menor consumo energético.
- Fabricación 100% en acero inoxidable 304.
- Válvula check integrada.



BOMBAS SUMERGIBLES

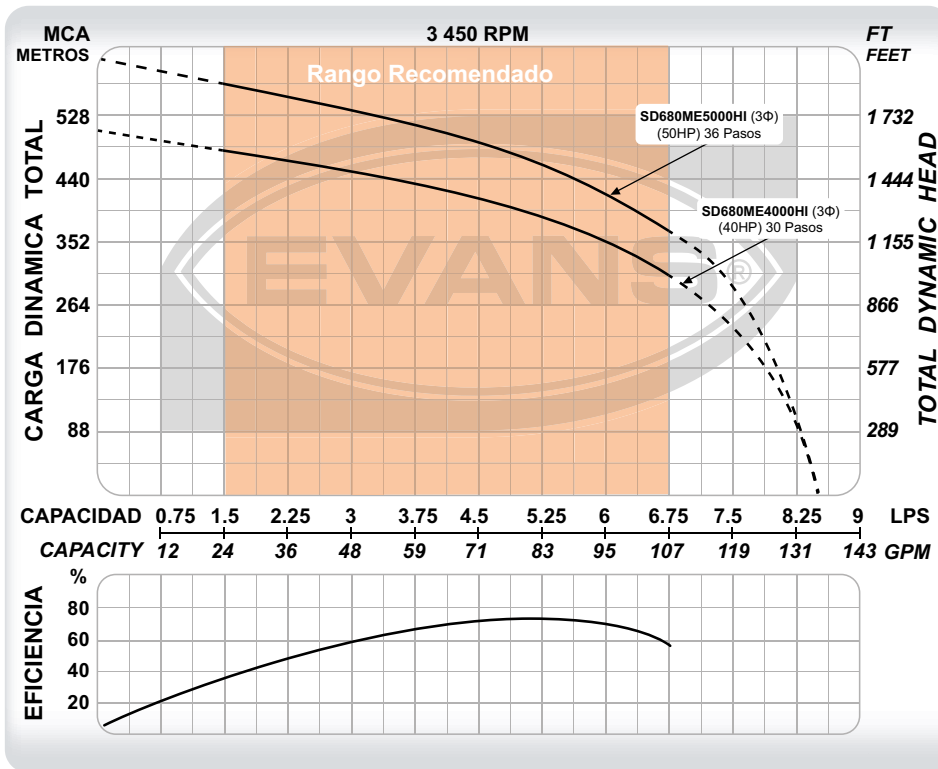

CÓDIGO	PESO	MEDIDAS LARGO X ANCHO X ALTO
SD680ME4000HI	121 kg	283 x 31 x 43 cm
SD680ME5000HI	144 kg	395 x 31 x 43 cm

CÓDIGO	Ø DESCARGA	POTENCIA	VOLTAJE	CORRIENTE	ETAPAS	FLUJO MÁXIMO	PRESIÓN MÁXIMA	PUNTO DE MAYOR EFICIENCIA
SD680ME4000HI	3"	40 HP	440 V ~ 60Hz 3Φ	65.2 A	30	8.5 l/s	505 m	5 l/s a 390 m
SD680ME5000HI	3"	50 HP	440 V ~ 60Hz 3Φ	86.3 A	36	8.5 l/s	606 m	5 l/s a 465 m



EQUIPO DE RIEGO SUMERGIBLE INOX. 6" | 130 GPM

CLASE 10

Desempeño de altura

BOMBAS SUMERGIBLES



- Bombas sumergibles para pozos profundos.
- La más eficiente en su categoría: mayor presión y flujo con menor consumo energético.
- Fabricación 100% en acero inoxidable 304.
- Válvula check integrada.

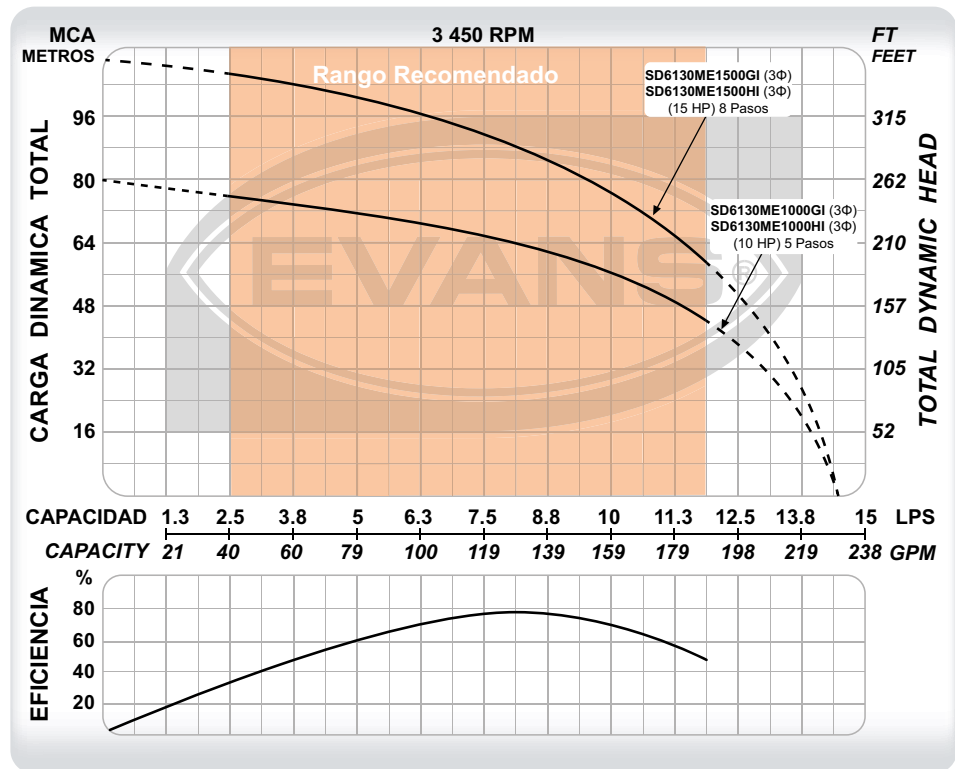

CÓDIGO	PESO	MEDIDAS
		LARGO X ANCHO X ALTO
SD6130ME1000GI	54 kg	160 x 31 x 43 cm
SD6130ME1500GI	67 kg	195 x 31 x 43 cm
SD6130ME1000HI	54 kg	160 x 31 x 43 cm
SD6130ME1500HI	67 kg	195 x 31 x 43 cm

CÓDIGO	Ø DESCARGA	POTENCIA	VOLTAJE	CORRIENTE	ETAPAS	FLUJO MÁXIMO	PRESIÓN MÁXIMA	PUNTO DE MAYOR EFICIENCIA
SD6130ME1000GI	3"	10 HP	220 V ~ 60Hz 3Φ	35 A	5	14.5 l/s	80 m	8 l/s a 63 m
SD6130ME1500GI	3"	15 HP	220 V ~ 60Hz 3Φ	49.7 A	8	14.5 l/s	110 m	8 l/s a 88 m
SD6130ME1000HI	3"	10 HP	440 V ~ 60Hz 3Φ	24.8 A	5	14.5 l/s	80 m	8 l/s a 63 m
SD6130ME1500HI	3"	15 HP	440 V ~ 60Hz 3Φ	24.8 A	8	14.5 l/s	110 m	8 l/s a 88 m

EQUIPO DE RIEGO SUMERGIBLE INOX. 6" | 130 GPM

Desempeño de altura

CLASE 10



- Bombas sumergibles para pozos profundos.
- La más eficiente en su categoría: mayor presión y flujo con menor consumo energético.
- Fabricación 100% en acero inoxidable 304.
- Válvula check integrada.



BOMBAS SUMERGIBLES

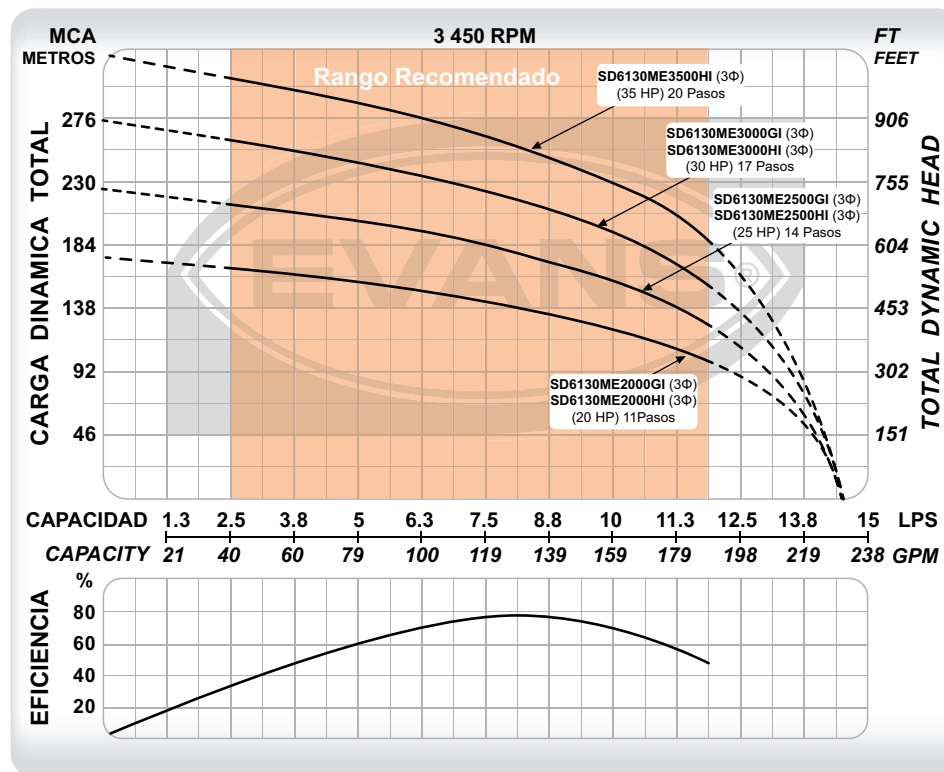

CÓDIGO	PESO	MEDIDAS LARGO X ANCHO X ALTO
SD6130ME2000GI	92 kg	231 x 31 x 43 cm
SD6130ME2500GI	100 kg	266 x 31 x 43 cm
SD6130ME3000GI	114 kg	301 x 31 x 43 cm
SD6130ME2000HI	92 kg	231 x 31 x 43 cm
SD6130ME2500HI	100 kg	266 x 31 x 43 cm
SD6130ME3000HI	114 kg	301 x 31 x 43 cm
SD6130ME3500HI	125 kg	335 x 31 x 43 cm

CÓDIGO	Ø DESCARGA	POTENCIA	VOLTAJE	CORRIENTE	ETAPAS	FLUJO MÁXIMO	PRESIÓN MÁXIMA	PUNTO DE MAYOR EFICIENCIA
SD6130ME2000GI	3"	20 HP	220 V ~ 60Hz 3Φ	64.9 A	11	14.5 l/s	176 m	8 l/s a 139 m
SD6130ME2500GI	3"	25 HP	220 V ~ 60Hz 3Φ	79.4 A	14	14.5 l/s	224 m	8 l/s a 176 m
SD6130ME3000GI	3"	30 HP	220 V ~ 60Hz 3Φ	93.8 A	17	14.5 l/s	273 m	8 l/s a 215 m
SD6130ME2000HI	3"	20 HP	440 V ~ 60Hz 3Φ	32.4 A	11	14.5 l/s	176 m	8 l/s a 139 m
SD6130ME2500HI	3"	25 HP	440 V ~ 60Hz 3Φ	39.7 A	14	14.5 l/s	224 m	8 l/s a 176 m
SD6130ME3000HI	3"	30 HP	440 V ~ 60Hz 3Φ	46.9 A	17	14.5 l/s	273 m	8 l/s a 215 m
SD6130ME3500HI	3"	35 HP	440 V ~ 60Hz 3Φ	58.7 A	20	14.5 l/s	321 m	8 l/s a 253 m



EQUIPO DE RIEGO SUMERGIBLE INOX. 6" | 130 GPM

CLASE 10

Desempeño de altura

BOMBAS SUMERGIBLES



- Bombas sumergibles para pozos profundos.
- La más eficiente en su categoría: mayor presión y flujo con menor consumo energético.
- Fabricación 100% en acero inoxidable 304.
- Válvula check integrada.

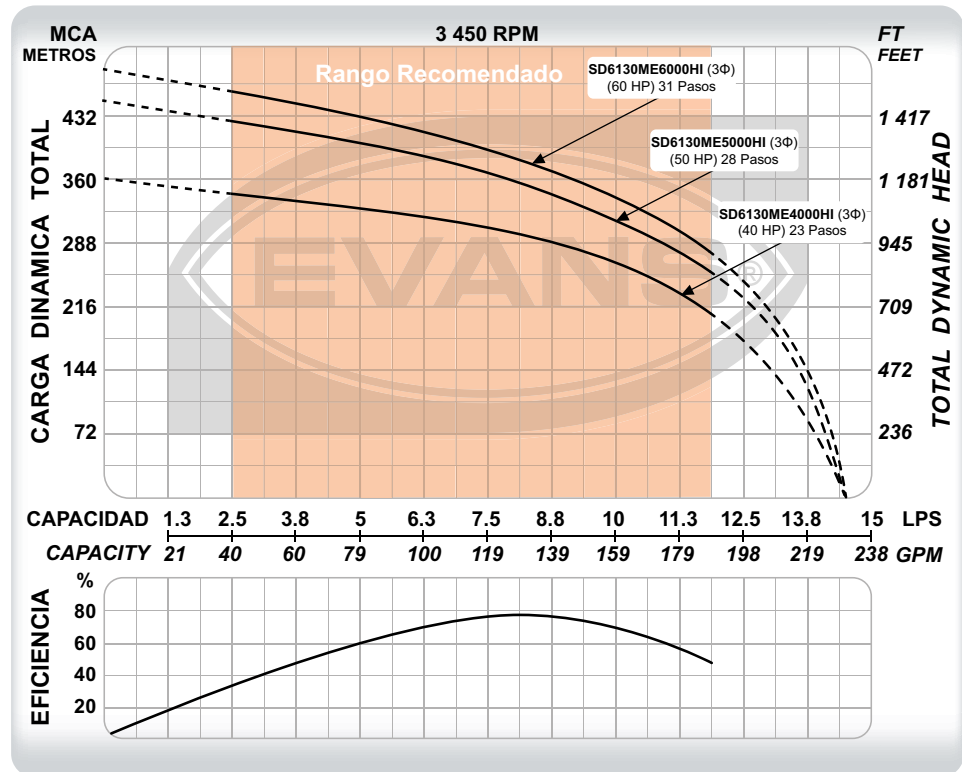

CÓDIGO	PESO	MEDIDAS
		LARGO X ANCHO X ALTO
SD6130ME4000HI	141 kg	368 x 31 x 43 cm
SD6130ME5000HI	155 kg	430 x 31 x 43 cm
SD6130ME6000HI	164 kg	482 x 31 x 43 cm

CÓDIGO	Ø DESCARGA	POTENCIA	VOLTAJE	CORRIENTE	ETAPAS	FLUJO MÁXIMO	PRESIÓN MÁXIMA	PUNTO DE MAYOR EFICIENCIA
SD6130ME4000HI	3"	40 HP	440 V ~ 60Hz 3Φ	65.2 A	23	14.5 l/s	360 m	8 l/s a 291 m
SD6130ME5000HI	3"	50 HP	440 V ~ 60Hz 3Φ	86.3 A	28	14.5 l/s	449 m	8 l/s a 358 m
SD6130ME6000HI	3"	60 HP	440 V ~ 60Hz 3Φ	103.5 A	31	14.5 l/s	485 m	8 l/s a 378 m

EQUIPO DE RIEGO SUMERGIBLE INOX. 6" | 200 GPM

Desempeño de altura

CLASE 10



- Bombas sumergibles para pozos profundos.
- La más eficiente en su categoría: mayor presión y flujo con menor consumo energético.
- Fabricación 100% en acero inoxidable 304.
- Válvula check integrada.



BOMBAS SUMERGIBLES

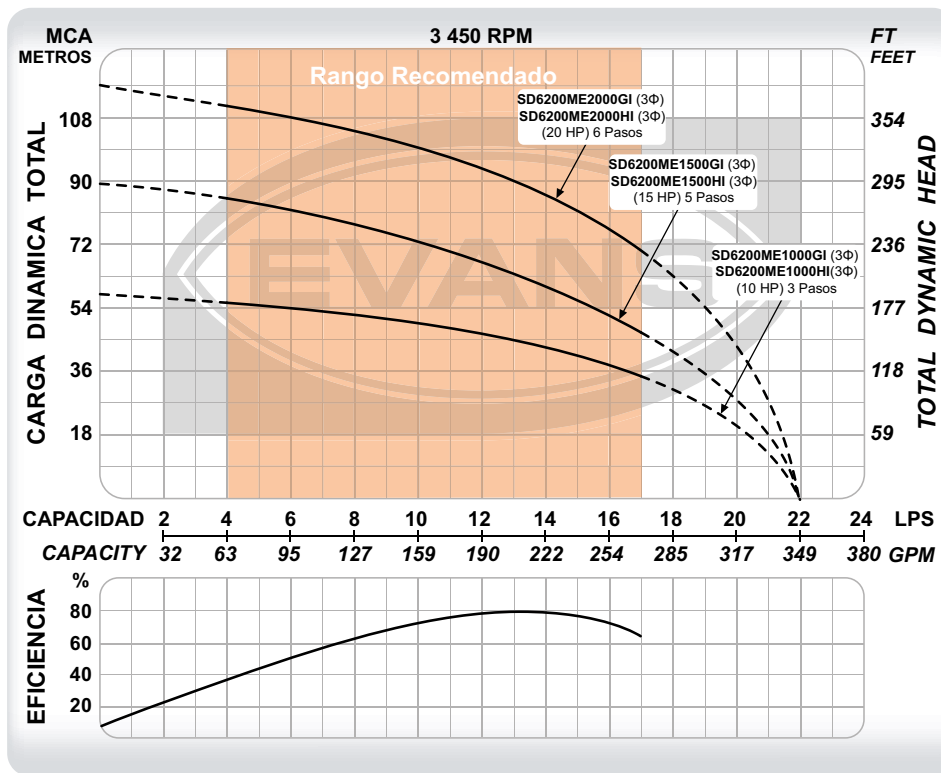

CÓDIGO	PESO	MEDIDAS
		LARGO X ANCHO X ALTO
SD6200ME1000GI	52 kg	146 x 31 x 43 cm
SD6200ME1500GI	64 kg	175 x 31 x 43 cm
SD6200ME2000GI	83 kg	193 x 31 x 43 cm
SD6200ME1000HI	52 kg	146 x 31 x 43 cm
SD6200ME1500HI	64 kg	175 x 31 x 43 cm
SD6200ME2000HI	83 kg	193 x 31 x 43 cm

CÓDIGO	Ø DESCARGA	POTENCIA	VOLTAJE	CORRIENTE	ETAPAS	FLUJO MÁXIMO	PRESIÓN MÁXIMA	PUNTO DE MAYOR EFICIENCIA
SD6200ME1000GI	4"	10 HP	220 V ~ 60Hz 3Φ	35 A	3	22 l/s	58 m	13 l/s a 45 m
SD6200ME1500GI	4"	15 HP	220 V ~ 60Hz 3Φ	49.7 A	5	22 l/s	89 m	13 l/s a 63 m
SD6200ME2000GI	4"	20 HP	220 V ~ 60Hz 3Φ	64.9 A	6	22 l/s	117 m	13 l/s a 89 m
SD6200ME1000HI	4"	10 HP	440 V ~ 60Hz 3Φ	17.5 A	3	22 l/s	58 m	13 l/s a 45 m
SD6200ME1500HI	4"	15 HP	440 V ~ 60Hz 3Φ	24.8 A	5	22 l/s	89 m	13 l/s a 63 m
SD6200ME2000HI	4"	20 HP	440 V ~ 60Hz 3Φ	32.4 A	6	22 l/s	117 m	13 l/s a 89 m



EQUIPO DE RIEGO SUMERGIBLE INOX. 6" | 200 GPM

CLASE 10

Desempeño de altura

BOMBAS SUMERGIBLES



- Bombas sumergibles para pozos profundos.
- La más eficiente en su categoría: mayor presión y flujo con menor consumo energético.
- Fabricación 100% en acero inoxidable 304.
- Válvula check integrada.

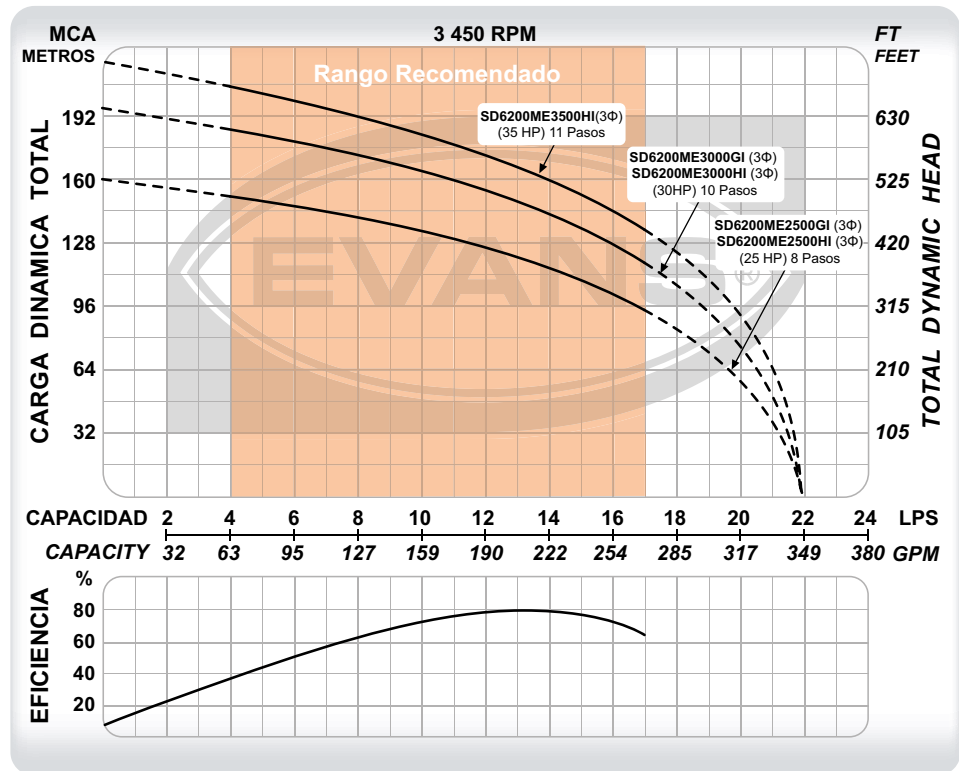

CÓDIGO	PESO	MEDIDAS
		LARGO X ANCHO X ALTO
SD6200ME2500GI	90 kg	222 x 31 x 43 cm
SD6200ME3000GI	102 kg	251 x 31 x 43 cm
SD6200ME2500HI	90 kg	222 x 31 x 43 cm
SD6200ME3000HI	102 kg	251 x 31 x 43 cm
SD6200ME3500HI	114 kg	267 x 31 x 43 cm

CÓDIGO	Ø DESCARGA	POTENCIA	VOLTAJE	CORRIENTE	ETAPAS	FLUJO MÁXIMO	PRESIÓN MÁXIMA	PUNTO DE MAYOR EFICIENCIA
SD6200ME2500GI	4"	25 HP	220 V ~ 60Hz 3Φ	79.4 A	8	22 l/s	159 m	13 l/s a 119 m
SD6200ME3000GI	4"	30 HP	220 V ~ 60Hz 3Φ	93.8 A	10	22 l/s	195 m	13 l/s a 146 m
SD6200ME2500HI	4"	25 HP	440 V ~ 60Hz 3Φ	39.7 A	8	22 l/s	159 m	13 l/s a 119 m
SD6200ME3000HI	4"	30 HP	440 V ~ 60Hz 3Φ	46.9 A	10	22 l/s	195 m	13 l/s a 146 m
SD6200ME3500HI	4"	35 HP	440 V ~ 60Hz 3Φ	58.7 A	11	22 l/s	218 m	13 l/s a 162 m

EQUIPO DE RIEGO SUMERGIBLE INOX. 6" | 200 GPM

Desempeño de altura

CLASE 10



- Bombas sumergibles para pozos profundos.
- La más eficiente en su categoría: mayor presión y flujo con menor consumo energético.
- Fabricación 100% en acero inoxidable 304.
- Válvula check integrada.



BOMBAS SUMERGIBLES

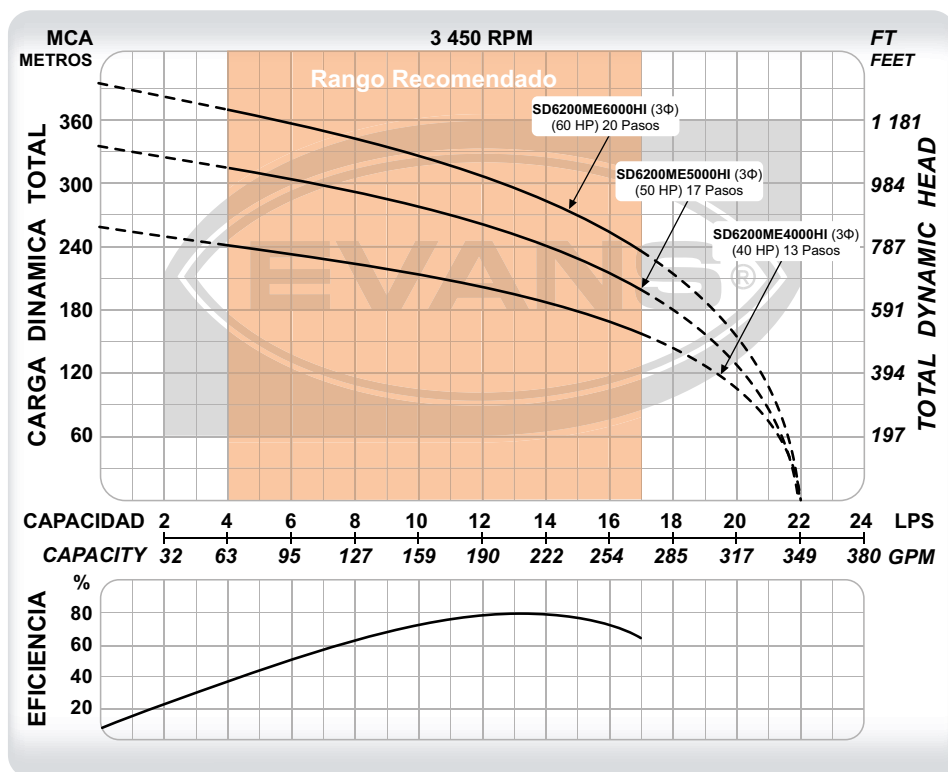

CÓDIGO	PESO	MEDIDAS LARGO X ANCHO X ALTO
SD6200ME4000HI	126 kg	295 x 31 x 43 cm
SD6200ME5000HI	138 kg	354 x 31 x 43 cm
SD6200ME6000HI	152 kg	403 x 31 x 43 cm

CÓDIGO	Ø DESCARGA	POTENCIA	VOLTAJE	CORRIENTE	ETAPAS	FLUJO MÁXIMO	PRESIÓN MÁXIMA	PUNTO DE MAYOR EFICIENCIA
SD6200ME4000HI	4"	40 HP	440 V ~ 60Hz 3Φ	65.2 A	13	22 l/s	258 m	13 l/s a 190 m
SD6200ME5000HI	4"	50 HP	440 V ~ 60Hz 3Φ	86.3 A	17	22 l/s	335 m	13 l/s a 247 m
SD6200ME6000HI	4"	60 HP	440 V ~ 60Hz 3Φ	103.5 A	20	22 l/s	394 m	13 l/s a 295 m



EQUIPO DE RIEGO SUMERGIBLE INOX. 6" I 270 GPM

CLASE 10

Desempeño de altura

BOMBAS SUMERGIBLES



- Bombas sumergibles para pozos profundos.
- La más eficiente en su categoría: mayor presión y flujo con menor consumo energético.
- Fabricación 100% en acero inoxidable 304.
- Válvula check integrada.

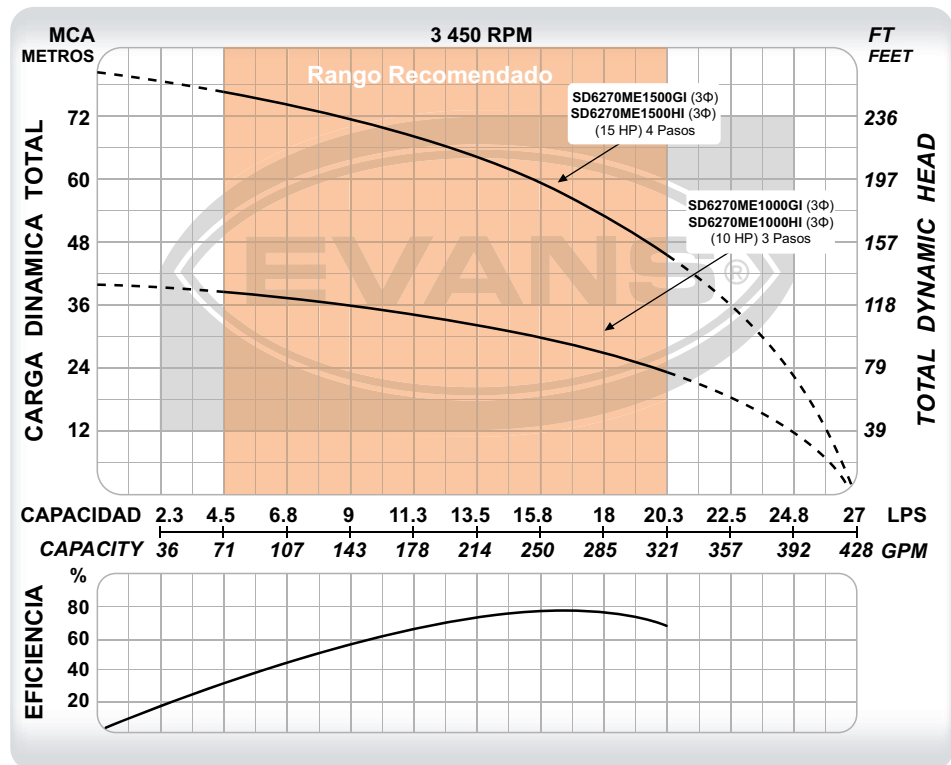

CÓDIGO	PESO	MEDIDAS LARGO X ANCHO X ALTO
SD6270ME1000GI	50 kg	134 x 31 x 43 cm
SD6270ME1500GI	62 kg	163 x 31 x 43 cm
SD6270ME1000HI	50 kg	134 x 31 x 43 cm
SD6270ME1500HI	62 kg	163 x 31 x 43 cm

CÓDIGO	Ø DESCARGA	POTENCIA	VOLTAJE	CORRIENTE	ETAPAS	FLUJO MÁXIMO	PRESIÓN MÁXIMA	PUNTO DE MAYOR EFICIENCIA
SD6270ME1000GI	4"	10 HP	220 V ~ 60Hz 3Φ	35 A	3	27 l/s	40 m	17 l/s a 28 m
SD6270ME1500GI	4"	15 HP	220 V ~ 60Hz 3Φ	49.7 A	4	27 l/s	80 m	17 l/s a 56 m
SD6270ME1000HI	4"	10 HP	440 V ~ 60Hz 3Φ	17.5 A	3	27 l/s	40 m	17 l/s a 28 m
SD6270ME1500HI	4"	15 HP	440 V ~ 60Hz 3Φ	24.8 A	4	27 l/s	80 m	17 l/s a 56 m

EQUIPO DE RIEGO SUMERGIBLE INOX. 6" | 270 GPM

Desempeño de altura

CLASE 10



- Bombas sumergibles para pozos profundos.
- La más eficiente en su categoría: mayor presión y flujo con menor consumo energético.
- Fabricación 100% en acero inoxidable 304.
- Válvula check integrada.



BOMBAS SUMERGIBLES

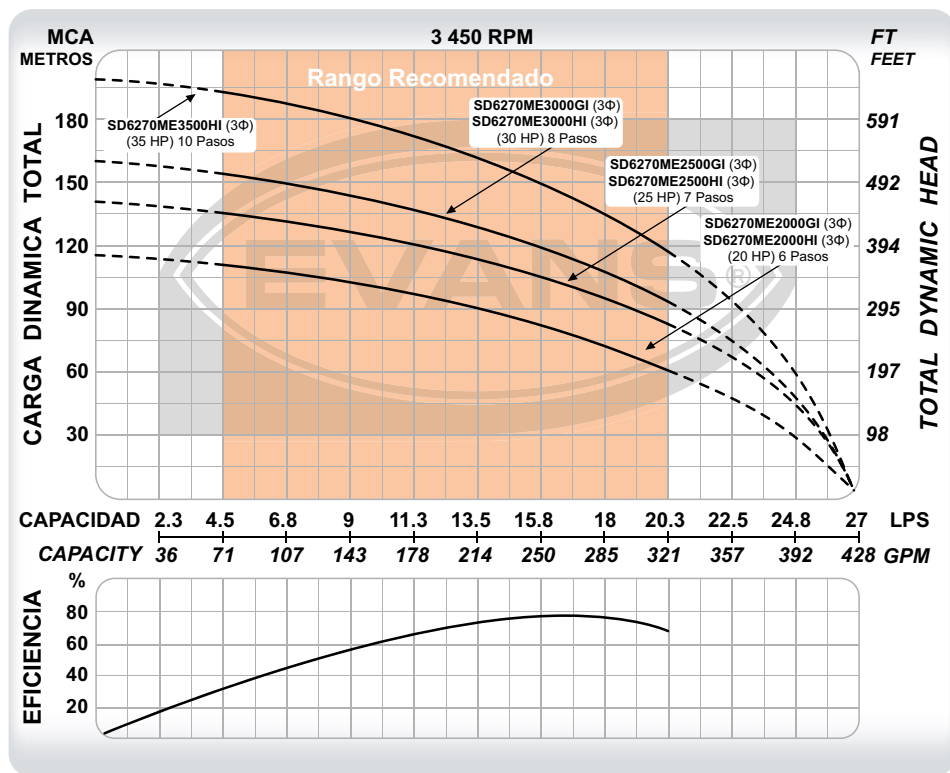

CÓDIGO	PESO	MEDIDAS
		LARGO X ANCHO X ALTO
SD6270ME2000GI	83 kg	193 x 31 x 43 cm
SD6270ME2500GI	88 kg	211 x 31 x 43 cm
SD6270ME3000GI	98 kg	228 x 31 x 43 cm
SD6270ME2000HI	83 kg	193 x 31 x 43 cm
SD6270ME2500HI	88 kg	211 x 31 x 43 cm
SD6270ME3000HI	98 kg	228 x 31 x 43 cm
SD6270ME3500HI	110 kg	256 x 31 x 43 cm

CÓDIGO	Ø DESCARGA	POTENCIA	VOLTAJE	CORRIENTE	ETAPAS	FLUJO MÁXIMO	PRESIÓN MÁXIMA	PUNTO DE MAYOR EFICIENCIA
SD6270ME2000GI	4"	20 HP	220 V ~ 60Hz 3Φ	64.9 A	6	27 l/s	116 m	17 l/s a 76 m
SD6270ME2500GI	4"	25 HP	220 V ~ 60Hz 3Φ	79.4 A	7	27 l/s	139 m	17 l/s a 98 m
SD6270ME3000GI	4"	30 HP	220 V ~ 60Hz 3Φ	93.8 A	8	27 l/s	160 m	17 l/s a 113 m
SD6270ME2000HI	4"	20 HP	440 V ~ 60Hz 3Φ	32.4 A	6	27 l/s	116 m	17 l/s a 76 m
SD6270ME2500HI	4"	25 HP	440 V ~ 60Hz 3Φ	39.7 A	7	27 l/s	139 m	17 l/s a 98 m
SD6270ME3000HI	4"	30 HP	440 V ~ 60Hz 3Φ	46.9 A	8	27 l/s	160 m	17 l/s a 113 m
SD6270ME3500HI	4"	35 HP	440 V ~ 60Hz 3Φ	58.7 A	10	27 l/s	197 m	17 l/s a 143 m



EQUIPO DE RIEGO SUMERGIBLE INOX. 6" I 270 GPM

CLASE 10

Desempeño de altura

BOMBAS SUMERGIBLES



- Bombas sumergibles para pozos profundos.
- La más eficiente en su categoría: mayor presión y flujo con menor consumo energético.
- Fabricación 100% en acero inoxidable 304.
- Válvula check integrada.

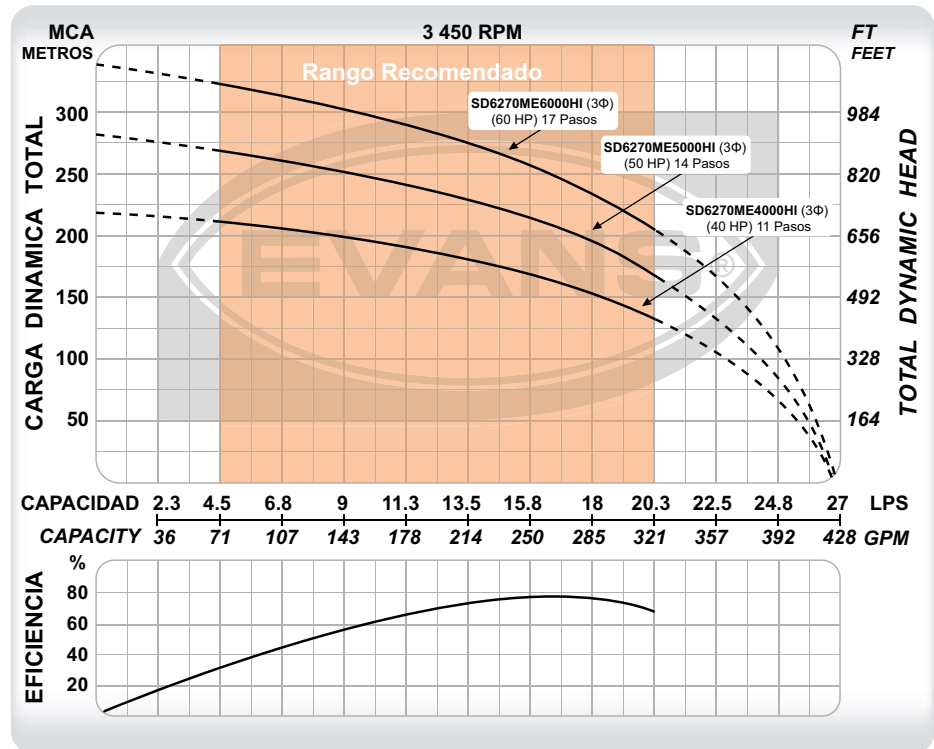

CÓDIGO	PESO	MEDIDAS
		LARGO X ANCHO X ALTO
SD6270ME4000HI	122 kg	272 x 31 x 43 cm
SD6270ME5000HI	134 kg	320 x 31 x 43 cm
SD6270ME6000HI	147 kg	369 x 31 x 43 cm

CÓDIGO	Ø DESCARGA	POTENCIA	VOLTAJE	CORRIENTE	ETAPAS	FLUJO MÁXIMO	PRESIÓN MÁXIMA	PUNTO DE MAYOR EFICIENCIA
SD6270ME4000HI	4"	40 HP	440 V ~ 60Hz 3Φ	65.2 A	11	27 l/s	218 m	17 l/s a 160 m
SD6270ME5000HI	4"	50 HP	440 V ~ 60Hz 3Φ	86.3 A	14	27 l/s	280 m	17 l/s a 204 m
SD6270ME6000HI	4"	60 HP	440 V ~ 60Hz 3Φ	103.5 A	17	27 l/s	335 m	17 l/s a 243 m

- Los motores sumergibles EVANS® de 8" tienen un mecanismo de enfriamiento a base de aceite de origen vegetal.
- Son compatible con las unidades de bombeo de diferentes marcas que tengan cumplimiento NEMA.
- Acoplamiento NEMA 8.
- Motor con embobinado de cobre y aislamiento CLASE F, cumpliendo con los estándares de NEMA MW37-C.
- Rodamientos suecos tipo bola de contacto angular especialmente diseñados para el trabajo continuo y soportar mayores cargas axiales.
- Altamente eficientes con la vida útil más larga del mercado. Soporta hasta 20 arranques.

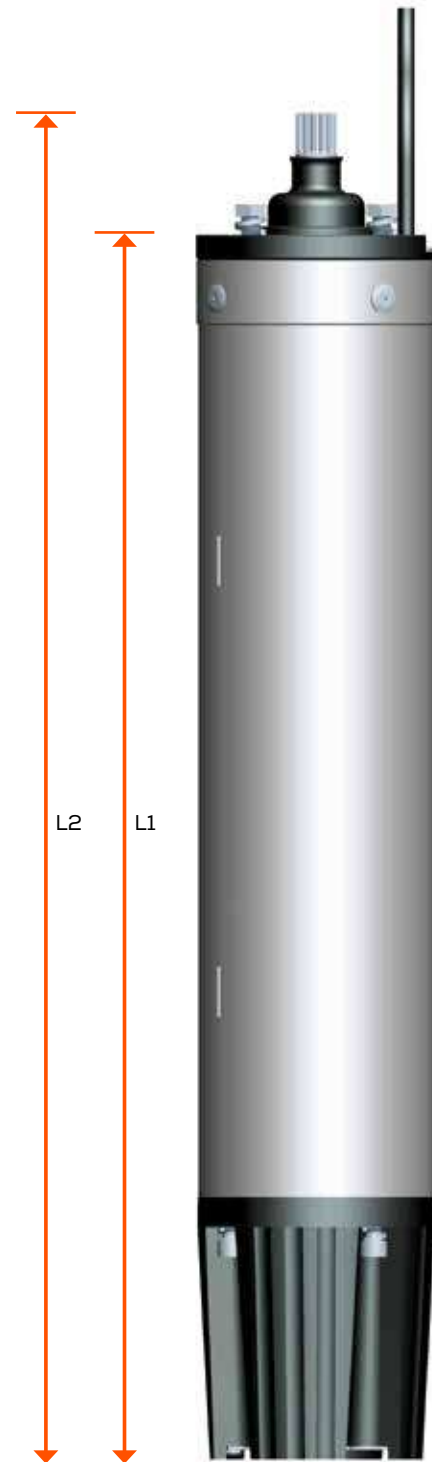
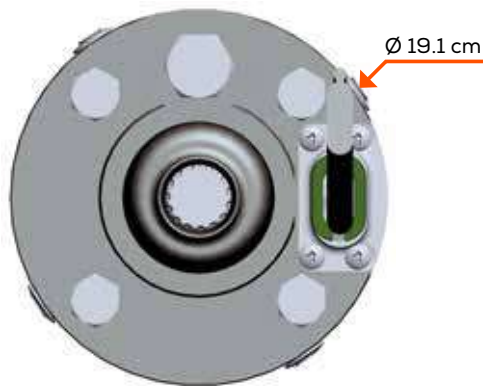

CÓDIGO	POTENCIA (HP)	L1 (cm)	L2 (cm)	PESO (kg)	VOLTAJE	CORRIENTE NOMINAL (A)	FACTOR SERVICIO	CORRIENTE MÁX. (A)	EMPUJE AXIAL (N)
E28S6000H-P	60	108.1	118.7	160	440V ~ 60Hz 3Φ	90	115	103.5	20 000
E28S7500H-P	75	115.5	125.7	180		113		130	
E28S10000H-P	100	131.5	141.7	230		150		172.5	

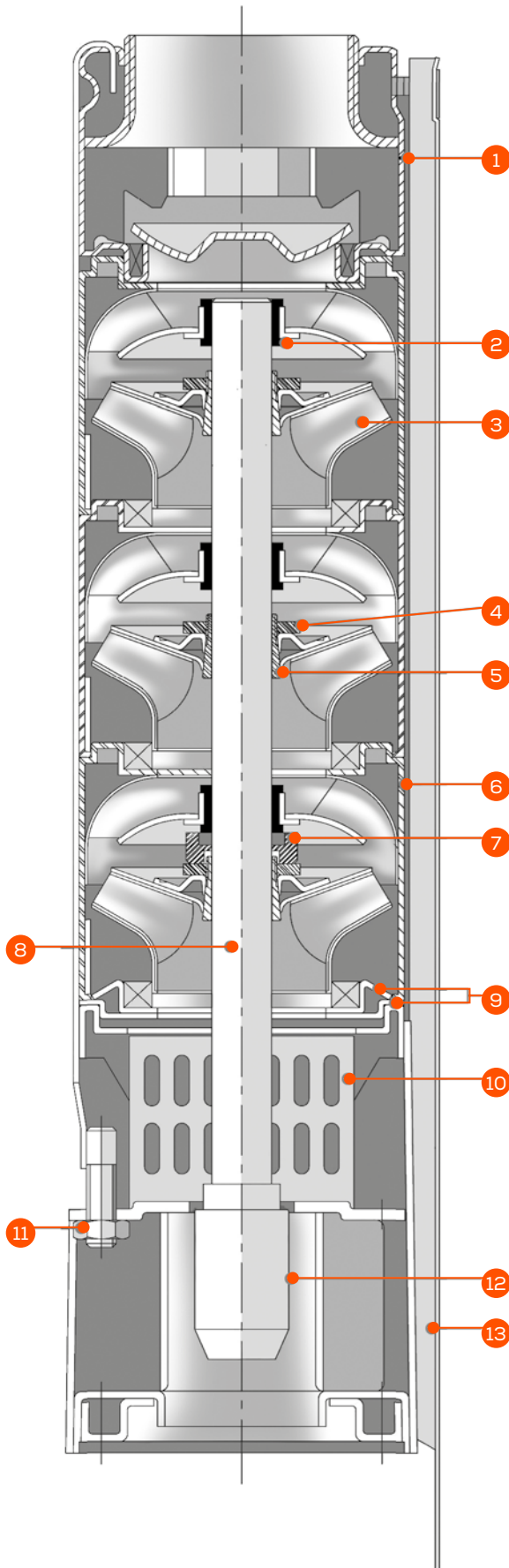

COMPONENTES	
No.	PARTES
1	Descarga
2	Rodamiento
3	Impulsor
4	Tuerca del separador
5	Separador de etapas
6	Difusor
7	Anillo de sujeción
8	Flecha
9	Retén
10	Rejilla de succión
11	Tornillo y tuerca
12	Cople
13	Guardacable

MATERIALES DE UNIDAD DE BOMBEO	
Material del cuerpo	AISI 304
Descarga	AISI 304
Succión	AISI 304
Flecha de bomba	AISI 431
Cople	AISI 304
Protector de cable	AISI 304
Soporte de válvula check	AISI 304
Impulsores	AISI 304
Difusores	AISI 304
Válvula check	AISI 304
Rodamientos de bomba	Buna-N
Acoplamiento	NEMA
Máx. contenido de arena	5% ~ 50g/m ³
Rango de pH líquido	5.5 - 8.9

EQUIPO DE RIEGO SUMERGIBLE INOX. 8" | 340 GPM

Desempeño de altura

CLASE 10



- Bombas sumergibles para pozos profundos.
- La más eficiente en su categoría: mayor presión y flujo con menor consumo energético.
- Fabricación 100% en acero inoxidable 304.
- Válvula check integrada.



BOMBAS SUMERGIBLES

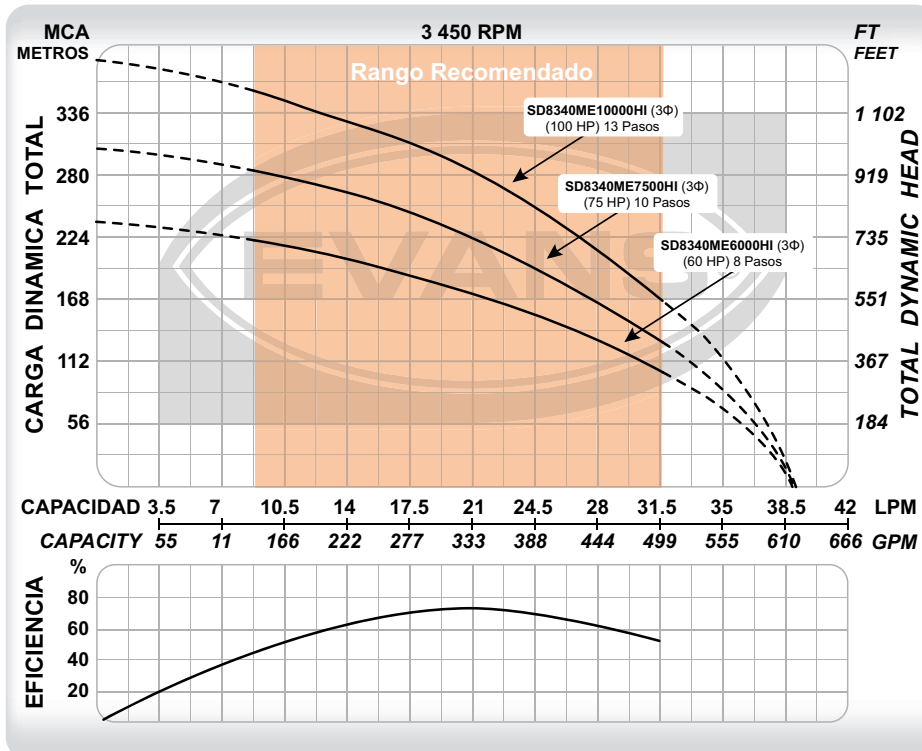

CÓDIGO	PESO	MEDIDAS LARGO X ANCHO X ALTO
SD8340ME6000HI	213	267 x 36 x 48 cm
SD8340ME7500HI	243	300 x 36 x 48 cm
SD8340ME10000HI	293	354 x 36 x 48 cm

CÓDIGO	Ø DESCARGA	POTENCIA	VOLTAJE	CORRIENTE	ETAPAS	FLUJO MÁXIMO	PRESIÓN MÁXIMA	PUNTO DE MAYOR EFICIENCIA
SD8340ME6000HI	6"	60 HP	440 V ~ 60Hz 3Φ	103.5 A	8	39 l/s	235 m	21 l/s a 170 m
SD8340ME7500HI	6"	75 HP	440 V ~ 60Hz 3Φ	130 A	10	39 l/s	300 m	21 l/s a 222 m
SD8340ME10000HI	6"	100 HP	440 V ~ 60Hz 3Φ	172.5 A	13	39 l/s	380 m	21 l/s a 281 m



EQUIPO DE RIEGO SUMERGIBLE INOX. 8" | 420 GPM

CLASE 10

Desempeño de altura

BOMBAS SUMERGIBLES



- Bombas sumergibles para pozos profundos.
- La más eficiente en su categoría: mayor presión y flujo con menor consumo energético.
- Fabricación 100% en acero inoxidable 304.
- Válvula check integrada.

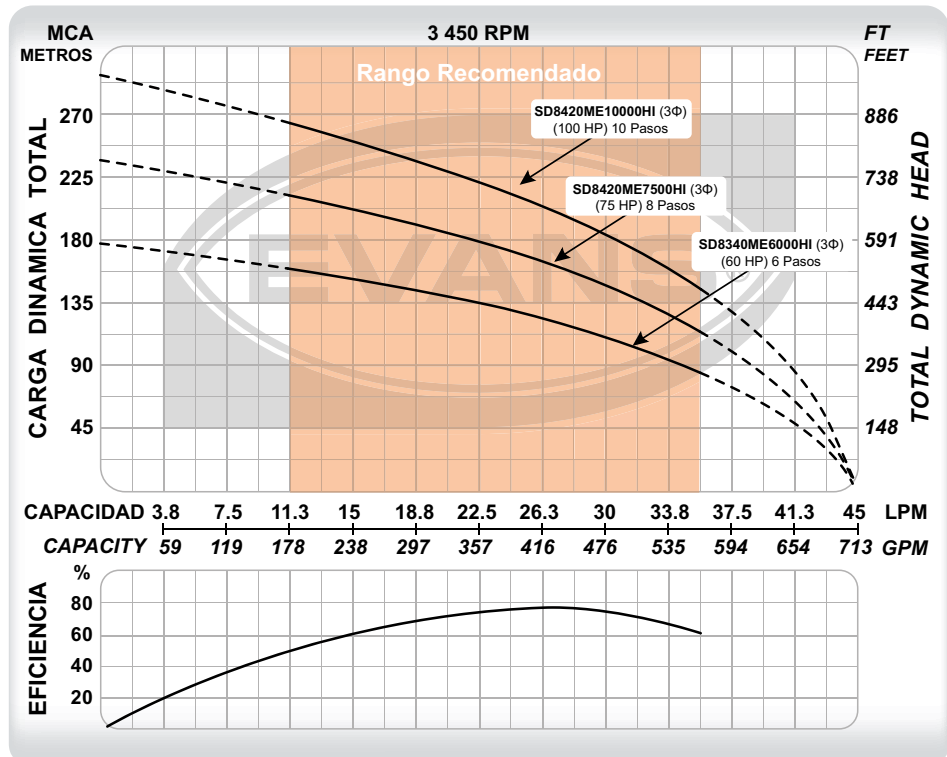

CÓDIGO	PESO	MEDIDAS
		LARGO X ANCHO X ALTO
SD8420ME6000HI	208 kg	240 x 36 x 48 cm
SD8420ME7500HI	238 kg	274 x 36 x 48 cm
SD8420ME10000HI	288 kg	316 x 36 x 48 cm

CÓDIGO	Ø DESCARGA	POTENCIA	VOLTAJE	CORRIENTE	ETAPAS	FLUJO MÁXIMO	PRESIÓN MÁXIMA	PUNTO DE MAYOR EFICIENCIA
SD8420ME6000HI	6"	60 HP	440 V ~ 60Hz 3Φ	103.5 A	6	45 l/s	175 m	26 l/s a 123 m
SD8420ME7500HI	6"	75 HP	440 V ~ 60Hz 3Φ	130 A	8	45 l/s	235 m	26 l/s a 162 m
SD8420ME10000HI	6"	100 HP	440 V ~ 60Hz 3Φ	172.5 A	10	45 l/s	295 m	26 l/s a 203 m

La tubería de columna en UPVC es una opción excelente para equipar pozos profundos ya que disminuye las pérdidas por fricción, elimina problemas de oxidación y reduce el peso y costo de la instalación. Su rosca cuadrada tiene mayor superficie de sujeción que la NPT y cada tramo incluye un o-ring interno para asegurar el correcto sellado de estos.

No requiere selladores ni herramientas para su instalación.

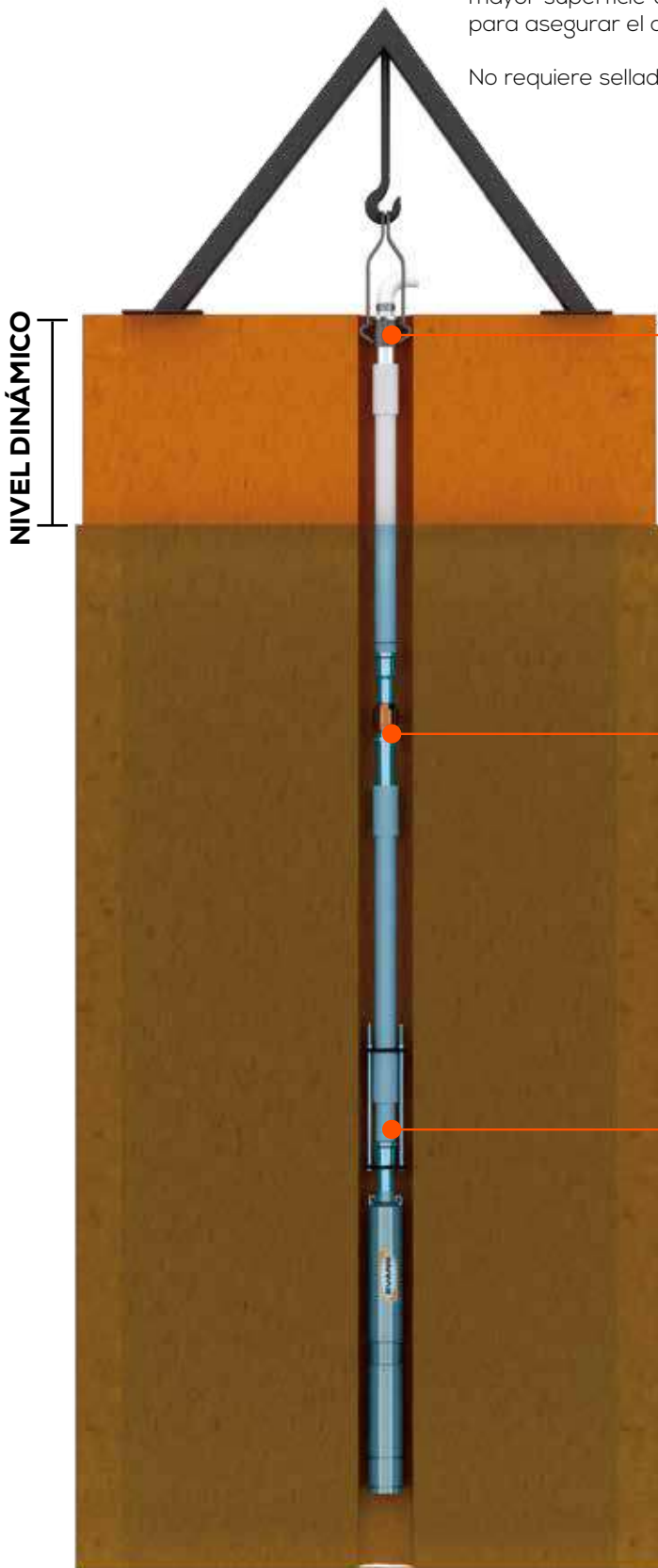

EJEMPLO DE INSTALACIÓN

ADAPTADOR DE COLUMNA/ RED HIDRÁULICA

Adaptador superior que convierte de rosca cuadrada a NPT y clamp de sujeción para maniobras.



KIT DE ADAPTADORES

También se pueden utilizar para instalar una válvula check entre tramos de UPVC. Recomendamos una válvula check cada 50m ó 16 tramos.



ARNES DE SUJECIÓN Y ADAPTADOR BOMBA/ COLUMNA

Adaptador inferior que convierte de rosca NPT a rosca cuadrada y arnés de sujeción para asegurar la bomba.





La relación de colores indica compatibilidad entre componentes.

TUBO DE COLUMNA UPVC MACHO /HEMBRA, ROSCA CUADRADA CON O-RING INTEGRADO. TRAMOS DE 2.8m DE LARGO

CÓDIGO	Ø DE CONEXIÓN	CARGA MÁXIMA	ESPELSOR	PRESIÓN MÁXIMA	CARGA DE ROTURA
● UPVC125-100M	1.25"	100 m	4.2 mm	20 (kg/cm ²)	2000 kg
● UPVC125-250M	1.25"	250 m	6.1 mm	30 (kg/cm ²)	3500 kg
● UPVC200-100M	2"	100 m	4.95 mm	20 (kg/cm ²)	3100 kg
● UPVC200-350M	2"	350 m	7.65 mm	35 (kg/cm ²)	4800 kg
● UPVC300-100M	3"	100 m	6.35 mm	30 (kg/cm ²)	5500 kg
● UPVC300-150M	3"	150 m	7.8 mm	35 (kg/cm ²)	7200 kg
● UPVC300-350M	3"	350 m	10.15 mm	40 (kg/cm ²)	10000 kg
● UPVC400-100M	4"	100 m	6.68 mm	30 (kg/cm ²)	7800 kg
● UPVC400-150M	4"	150 m	8.4 mm	35 (kg/cm ²)	12000 kg
● UPVC400-350M	4"	350 m	12.15 mm	40 (kg/cm ²)	18000 kg

KIT DE CONECTORES PARA ADAPTAR EL PRIMER TRAMO DE TUBERÍA CON LA DESCARGA DE LA BOMBA Y EL ÚLTIMO CON LA RED HIDRÁULICA

CÓDIGO	Ø DE CONEXIÓN	CARGA MÁXIMA	ESPELSOR
● KIT125-HG150	1.25"	150 m	Hierro gris
● KIT200-HG150	2"	150 m	
● KIT300-HG150	3"	150 m	
● KIT400-HG150	4"	150 m	
● KIT125-SS150	1.25"	150 m	Acero inoxidable
● KIT200-SS150	2"	150 m	
● KIT300-SS150	3"	150 m	
● KIT400-SS150	4"	150 m	
● KIT125-SS250	1.25"	250 m	
● KIT400-SS450	4"	450 m	
● KIT200-SS450	2"	450 m	
● KIT300-SS450	3"	450 m	



ARNES DE SUJECIÓN PARA LA BOMBA

CÓDIGO	Ø DE CONEXIÓN
● KIT200-ARNES	2"
● KIT300-ARNES	3"
● KIT400-ARNES	4"



LLAVE CON CORREA AJUSTABLE

CÓDIGO	Ø DE CONEXIÓN
LLAVE-EVANS	1.25" - 6"



ABRAZADERA EN HIERRO GRIS PARA MANIOBRAR BOMBA ACOPLADA A TUBO DE COLUMNA

CÓDIGO	Ø DE CONEXIÓN
CLAMP125	1.25"
CLAMP200	2"
CLAMP300	3"
CLAMP400	4"





ABB

Los arrancadores por variador de frecuencia están especialmente diseñados para accionar bombas sumergibles de pozo profundo con arranque suave, evitando picos de corriente durante el arranque, ahorrando así energía y alargando la vida útil del motor por reducir su desgaste.

Usando estos gabinetes en aplicaciones sin acceso a energía eléctrica de la red pública y sea necesario utilizar un generador, este no se sobredimensiona tanto en comparación con arranque a tensión plena o inclusive arranque suave convencional. Reduciendo exponencialmente el tamaño del generador y la inversión necesaria para accionar la bomba.

Se cuentan con 2 versiones: la versión "50M" para casos donde la longitud del conductor que conecta el motor y el gabinete NO excede los 50m y otra para cuando esta distancia sea mayor, la cual soporta hasta 500m. La versión "500M", incluye un filtro de tipo dv/dt, para atenuar los armónicos generados naturalmente en grandes distancias por las variaciones de frecuencia.

Ambas versiones se surten con flotador para controlar el llenado de depósitos, electrodos para proteger la bomba contra corrida en seco por pozo abatido, así como protecciones por caída de fase, corto circuito y sobre voltaje.

El equipo se surte con un gabinete termoplástico con ventilación y grado de protección IP55.

Para conocer la corriente de alimentación y corriente máxima de salida del equipo, consulte la sección de variador/inversor EVANS-SOLAR® (página 131).

ATENCIÓN: ESTE EQUIPO INCLUYE UN VARIADOR DE FRECUENCIA CUYA FUNCIÓN ES ARRANCAR LA BOMBA CON RAMPA DE ACELERACIÓN SUAVE POR MEDIO DE FRECUENCIA VARIABLE. SIN EMBARGO ESTE VARIADOR NO SE PUEDE INSTALAR CON TRANSDUCTOR DE FRECUENCIA Y SUMINISTRAR PRESIÓN CONSTANTE. EL VARIADOR QUE SE INCLUYE ES DE LA FAMILIA EVANS-SOLAR.



AB - AVF 5 G - 50M
1 2 3 4 5

- 1 ACCESORIO BOMBA
- 2 ARRANCADOR POR VARIADOR DE FRECUENCIA
- 3 POTENCIA DE LA BOMBA

5	5 HP 3Φ	25	25 HP 3Φ
7.5	7.5 HP 3Φ	30	30 HP 3Φ
10	10 HP 3Φ	40	40 HP 3Φ
15	15 HP 3Φ	50	50 HP 3Φ
20	20 HP 3Φ		

- 4 VOLTAJE

G	220V ~ 60 Hz
H	440V ~ 60 Hz
- 5 DISTANCIA MÁXIMA ENTRE EL GABINETE Y LA BOMBA

50 M	50 metros
500 M	500 metros



EVANS®

DESEMPEÑO de ALTURA

- Ideales para la extracción de agua, en pozos profundos.
- La mejor eficiencia y desempeño en su categoría mayor presión y flujo con menor consumo energético.
- Impulsores en acero inoxidable de 4", 6" y 8" y en noryl de 4".



evans.com.mx